

PennEngineering®

**FASTENERS FOR
USE WITH PC BOARDS**



BULLETIN

K



712
REV 1012

FASTENERS FOR USE WITH PC BOARDS

NUTS AND SPACERS/STANDOFFS



Type SMTSO - ReelFast® surface mount nuts and standoffs are available threaded and unthreaded - **PAGE 4**



Type KF2 and KFS2 - Broaching nuts, internally threaded for mounting on PC boards - **PAGE 5**



Type KFE and KFSE - Broaching standoffs, threaded or unthreaded for stacking or spacing - **PAGE 6**



Type KFB3 - Broach/flare-mount standoffs with greater pullout performance - **PAGE 6**



Type KSSB - Broaching, SNAP-TOP® standoffs feature a spring action to hold PC board securely without screws or threaded hardware - **PAGE 7**

CAPTIVE PANEL SCREWS



ReelFast® surface mount captive panel screws - **PAGE 8**



Type PFK - Broaching panel fastener assemblies for mounting on PC boards - **PAGE 9**

STUDS



Type KFH - Threaded broaching studs for use as solderable connectors or as permanently mounted studs on PC boards - **PAGE 10**

RIGHT ANGLE FASTENERS



Type SMTRA - ReelFast® R'ANGLE® surface mount fasteners provide strong re-usable threads at right angles to PC boards - **PAGE 11**

SHEET JOINING FASTENERS



Type SFK - SpotFast® clinch/broach mount fasteners for joining metal to PCB/plastic panels - **PAGE 12**

MATERIAL AND FINISH SPECIFICATIONS - PAGE 13

INSTALLATION - PAGES 14-15

PERFORMANCE DATA - PAGES 16-17

OTHER FASTENERS FOR USE WITH PC BOARDS - PAGE 18

NOTE ABOUT PLATED THRU-HOLES

Broaching and broach/flare types are designed for unplated thru-hole applications. If used in plated thru-hole applications, the stresses involved can damage the plating, push out the plating entirely, or break any traces inside the board that might be connected to the plated hole. Increasing the mounting hole size $+0.005$ " to $+0.008$ " $/+0.13$ to $+0.2$ may relieve these conditions. In non-plated thru-holes this will also help when delamination, measeling or crazing is evident after installation. When none of the above can be tolerated, we recommend Type SMTSO (surface-mount) type fasteners.

General recommendations for "Keep Out" areas are the same as our "Min. Distance Hole C/L to Edge" dimensions stated in the dimensional charts of our bulletin.

FASTENERS FOR USE WITH PC BOARDS

No matter how sophisticated or advanced, electronic components must be attached reliably and securely if they are to deliver optimum performance. We offer several fastener products for use with PC boards to satisfy component-to-board, board-to-board, and board-to-chassis attachment needs.

ReelFast® surface mount fasteners mount on PC boards in the same manner and at the same time as other surface mount components prior to the automated reflow solder process. The fasteners simply become another board component. This alleviates concerns about potential damage to PC boards due to improper secondary installation operations. The fasteners are provided on tape and reel compatible with existing SMT automated installation equipment. The benefits of using ReelFast® SMT fasteners are: faster assembly; reduced scrap; reduced handling; and reduced risk of board damage.

Broaching fasteners can also offer practical alternatives to “loose” hardware. A broaching fastener is a knurled-shank fastening device that can be pressed into a hole to provide a permanent, strong, threaded or unthreaded attachment point in PC boards. They can also be used in aluminum, acrylic, casting and polycarbonate components. Specially formed axial grooves around the shank of the fastener “broach” or cut into the material, creating a firm, interference-type fit resistant to rotation. In PC boards, broaching fasteners are recommended for use in non-plated holes.

Broach/flare-mount standoffs (Type KFB3) offer a combined broach/flare feature for even greater pullout performance in PC board materials.

QUICK REFERENCE CHART

PEM Fastener Type	Page No.	Mounting Types				Primary Use							
		Broach	Broach/Flare	Surface	Clinch/Broach	Nut	Spacer/Standoff	Snap Attachment	Stud	Captive Screw	Color Coding	Right Angle Attachment	Sheet Joining
SMTSO Nut/Spacer/Standoff	4			•		•	•						
KF2/KFS2 Nut	5	•				•							
KFE/KFSE Spacer/Standoff	6	•					•						
KFB3 Standoff	6		•				•						
KSSB Standoff	7	•					•	•					
SMPF Assembly	8			•						•	•		
PFK Captive Screw	9	•								•			
KFH Stud	10	•							•				
SMTRA Right Angle	11			•								•	
SFK Sheet Joining	12	•			•								•

FASTENERS FOR USE WITH PC BOARDS

TYPE SMTSO ReelFast® SURFACE MOUNT NUTS AND SPACERS/STANDOFFS

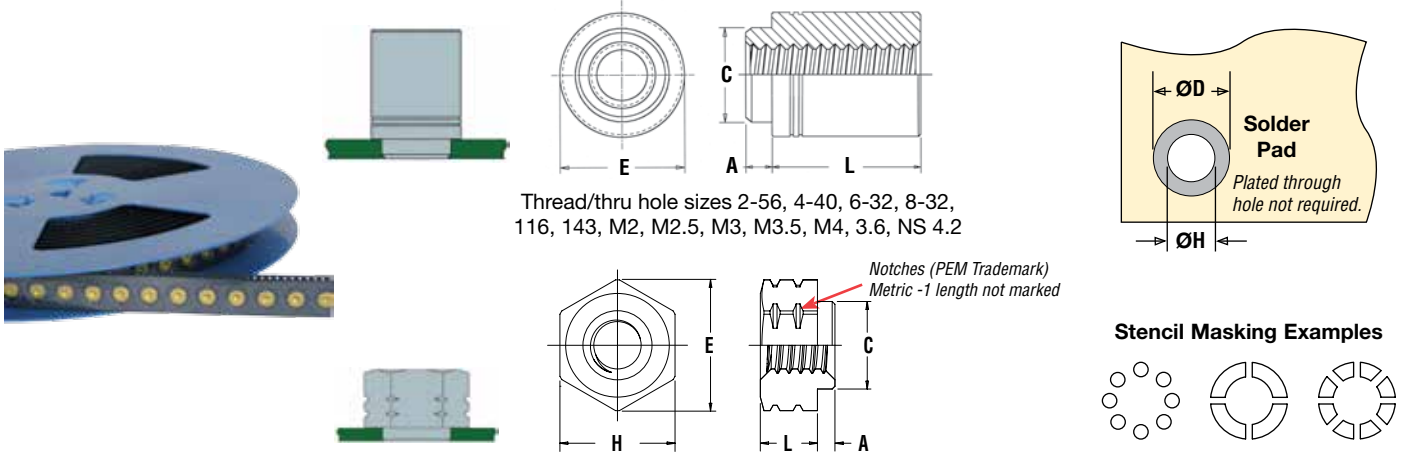

Thread/thru hole sizes 2-56, 4-40, 6-32, 8-32, 116, 143, M2, M2.5, M3, M3.5, M4, 3.6, NS 4.2

Thread sizes 080, S1, S1.2, S1.4 and M1.6

All dimensions are in inches.

UNIFIED	Thread Size	Thru Hole +.004 -.003	Type	Thread or Thru Hole Code	Length Code "L" ±.005 (Length code in 32nds of an inch)				Min. Sheet Thickness	A Max.	C Max.	E ±.005	H Nom.	ØH Hole Size In Sheet +.003 -.000	ØD Min. Solder Pad
					.062	.125	.250	.375							
					.060-80 (#0-80)	—	SMTSO	080							
.086-56 (#2-56)	—	SMTSO	256	2	4	8	12	.060	.060	.142	.219	—	.147	.244	
.112-40 (#4-40)	—	SMTSO	440	2	4	8	12	.060	.060	.161	.219	—	.166	.244	
.138-32 (#6-32)	—	SMTSO	632	2	4	8	12	.060	.060	.208	.281	—	.213	.306	
.164-32 (#8-32)	—	SMTSO	832	2	4	8	12	.060	.060	.245	.344	—	.250	.369	
—	.116	SMTSO	116	2	4	8	12	.060	.060	.161	.219	—	.166	.244	
—	.143	SMTSO	143	2	4	8	12	.060	.060	.208	.281	—	.213	.306	

All dimensions are in millimeters.

METRIC	Thread Size x Pitch	Thru Hole +0.10 -0.08	Type	Thread or Thru Hole Code	Length Code "L" ±0.13 (Length code in millimeters)								Min. Sheet Thickness	A Max.	C Max.	E ±0.13	H Nom.	ØH Hole Size In Sheet +0.08	ØD Min. Solder Pad
					1	2	3	NA	NA	NA	NA	NA							
					S1	—	SMTSO	M1	1	2	3	NA							
S1.2	—	SMTSO	M1.2	1	2	3	NA	NA	NA	NA	0.5	0.48	2.41	3.66	3.18	2.5	4.19		
S1.4	—	SMTSO	M1.4	1	2	3	NA	NA	NA	NA	0.5	0.48	2.41	3.66	3.18	2.5	4.19		
M1.6 x 0.35	—	SMTSO	M1.6	1	2	3	NA	NA	NA	NA	0.5	0.48	2.41	3.66	3.18	2.5	4.19		
M2 x 0.4	—	SMTSO	M2	NA	2	3	4	6	8	10	1.53	1.53	3.6	5.56	—	3.73	6.2		
M2.5 x 0.45	—	SMTSO	M25	NA	2	3	4	6	8	10	1.53	1.53	4.09	5.56	—	4.22	6.2		
M3 x 0.5	—	SMTSO	M3	NA	2	3	4	6	8	10	1.53	1.53	4.09	5.56	—	4.22	6.2		
M3.5 x 0.6	—	SMTSO	M35	NA	2	3	4	6	8	10	1.53	1.53	5.28	7.14	—	5.41	7.77		
M4 x 0.7	—	SMTSO	M4	NA	2	3	4	6	8	10	1.53	1.53	6.22	8.74	—	6.35	9.37		
—	3.6	SMTSO	3.6	NA	2	3	4	6	8	10	1.53	1.53	5.28	7.14	—	5.41	7.77		
—	4.2	SMTSO	4.2	NA	2	3	4	6	8	10	1.53	1.53	6.22	8.74	—	6.35	9.37		

NUMBER OF PARTS PER REEL / PITCH (MM) FOR EACH SIZE

Thread/Thru-Hole Size	Length Code							
	1	2	3	4	6	8	10	12
080	—	3500 / 8	—	2000 / 8	—	—	—	—
256, 440, 632, 116, 143	—	1500 / 12	—	1000 / 12	—	650 / 12	—	300 / 16
832	—	1100 / 16	—	800 / 16	—	500 / 16	—	300 / 16
M1, M1.2, M1.4, M1.6	3500 / 8	2500 / 8	2000 / 8	—	—	—	—	—
M2, M25, M3, M35, 3.6	—	1500 / 12	1000 / 12	900 / 12	650 / 12	375 / 16	300 / 16	—
M4, 4.2	—	1100 / 16	800 / 16	675 / 16	500 / 16	375 / 16	300 / 16	—

PART NUMBER DESIGNATION

SMTSO - 440 - 8 ET

↓ ↓ ↓ ↓

Type Thread or Thru Hole Code Length Code Finish Code

Packaged on 13" recyclable reels. Tape width is 24mm. Supplied with polyimide patch for vacuum pick up. Reels conform to EIA-481.



FASTENERS FOR USE WITH PC BOARDS

TYPES KF2 AND KFS2 BROACHING NUTS

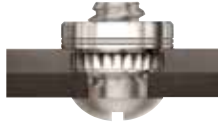

PART NUMBER DESIGNATION

KFS2 - 832
KF2 - 832 - ET

↓ ↓ ↓
 Type and Thread Finish
 Material Code Code
 KF2 = carbon steel
 KFS2 = stainless steel

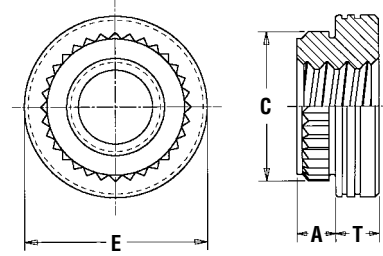

All dimensions are in inches.

UNIFIED	Thread Size	Type		Thread Code	A (Shank) Max.	Min. Sheet Thickness	Hole Size In Sheet +.003 - .000	C ±.003	E ±.005	T ±.005	Min. Dist. Hole ϕ To Edge
		Carbon Steel	Stainless Steel								
	.086-56 (#2-56)	KF2	KFS2	256	.060	.060	.147	.165	.219	.065	0.16
	.112-40 (#4-40)	KF2	KFS2	440	.060	.060	.166	.184	.219	.065	0.17
	.138-32 (#6-32)	KF2	KFS2	632	.060	.060	.213	.231	.281	.065	0.22
	.164-32 (#8-32)	KF2	KFS2	832	.060	.060	.250	.268	.344	.096	0.25
	.190-32 (#10-32)	KF2	KFS2	032	.060	.060	.272	.290	.375	.127	0.28

All dimensions are in millimeters.

METRIC	Thread Size x Pitch	Type		Thread Code	A (Shank) Max.	Min. Sheet Thickness	Hole Size In Sheet +0.08	C ±0.08	E ±0.13	T ±0.13	Min. Dist. Hole ϕ To Edge
		Carbon Steel	Stainless Steel								
	M2 x 0.4	KF2	KFS2	M2	1.53	1.53	3.73	4.19	5.56	1.5	4.2
	M2.5 x 0.45	KF2	KFS2	M2.5	1.53	1.53	4.22	4.68	5.56	1.5	4.4
	M3 x 0.5	KF2	KFS2	M3	1.53	1.53	4.22	4.68	5.56	1.5	4.4
	M4 x 0.7	KF2	KFS2	M4	1.53	1.53	6.4	6.81	8.74	2	6.4
	M5 x 0.8	KF2	KFS2	M5	1.53	1.53	6.9	7.37	9.53	3	7.1

FASTENERS FOR USE WITH PC BOARDS

TYPES KFE AND KFSE BROACHING STANDOFFS



PART NUMBER DESIGNATION

KFSE - 632 - 12
KFE - 632 - 12 **ET**
 ↓ ↓ ↓ ↓
 Type and Thread Length Finish
 Material or Thru Code Code
 KFE = carbon steel Hole Code
 KFSE = stainless steel

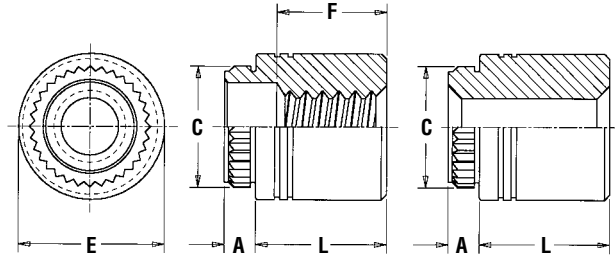

All dimensions are in inches.

UNIFIED	Thread Size	Thru Hole +.004 -.003	Type		Thread or Thru Hole Code	Length "L" ±.005 (Length Code is in 32nds of an inch)								A (Shank) Max.	Min. Sheet Thickness	Hole Size In Sheet +.003 - .000	C ±.003	E ±.005	Min. Dist. Hole \varnothing To Edge
			Carbon Steel	Stainless Steel		.125	.250	.375	.500	.625	(1) .750	(1) .875	(1) 1.00						
			(2)	(2)		4	8	12	16	20	24	28	32						
.112-40 (#4-40)	(2)		KFE	KFSE	440	4	8	12	16	20	24	NA	NA	.060	.060	.166	.184	.219	.17
.138-32 (#6-32)	(2)		KFE	KFSE	632	4	8	12	16	20	24	28	32	.060	.060	.213	.231	.281	.22
	(2)	.116	KFE	KFSE	116	4	8	12	16	20	24	NA	NA	.060	.060	.166	.184	.219	.17
	(2)	.143	KFE	KFSE	143	4	8	12	16	20	24	28	32	.060	.060	.213	.231	.281	.22
"F" Minimum Thread Length (Where Applicable)						Full			.375 ±.016			.375 Blind							

All dimensions are in millimeters.

METRIC	Thread Size x Pitch	Thru Hole +0.10 -0.08	Type		Thread or Thru Hole Code	Length "L" ±0.13 (Length Code is in millimeters)								A (Shank) Max.	Min. Sheet Thickness	Hole Size In Sheet +0.08	C ±0.08	E ±0.13	Min. Dist. Hole \varnothing To Edge
			Carbon Steel	Stainless Steel		3	4	6	8	10	12	14	16						
			(2)	(2)		3	4	6	8	10	12	14	16						
M3 x 0.5	(2)		KFE	KFSE	M3	3	4	6	8	10	12	14	16	1.53	1.53	4.22	4.68	5.56	4.4
	(2)	3.6	KFE	KFSE	3.6	3	4	6	8	10	12	14	16	1.53	1.53	5.41	5.87	7.14	5.5
	(2)	4.2	KFE	KFSE	4.2	3	4	6	8	10	12	14	16	1.53	1.53	6.4	6.86	8.74	7.1
"F" Minimum Thread Length (Where Applicable)						Full			9.5 ± 0.4										

TYPE KFB3 BROACH/FLARE-MOUNT STANDOFFS



PART NUMBER DESIGNATION

KFB3 - 632 - 12 **ET**
 ↓ ↓ ↓ ↓
 Type and Thread Length Finish
 Material Code Code Code

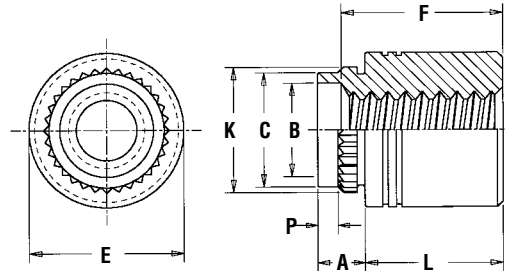

All dimensions are in inches.

UNIFIED	Thread Size	Type	Thread Code	Length "L" ±.005 (Length Code is in 32nds of an inch)								A (Shank) Max.	Sheet Thickness	Hole Size in Sheet +.005 -.001	B ±.003	C Max.	E ±.005	K ±.003	P ±.010	Min. Dist. Hole \varnothing To Edge		
				.062	.125	.187	.250	.312	.375	.500	.625										(1) .750	(1) 1.00
				(2)	(2)	(2)	(2)	(2)	(2)	(2)	(2)										(2)	(2)
.112-40 (#4-40)	KFB3	440	2	4	6	8	10	12	16	20	NA	NA	.09	.050-.065	.166	.122	.165	.219	.179	.040	.17	
.138-32 (#6-32)	KFB3	632	2	4	6	8	10	12	16	20	24	32	.09	.050-.065	.213	.171	.212	.280	.226	.040	.22	
"F" Min. Thread Length (Where Applicable)				Full			.375 Blind															

All dimensions are in millimeters.

METRIC	Thread Size x Pitch	Type	Thread Code	Length "L" ±0.13 (Length Code is in millimeters)								A (Shank) Max.	Sheet Thickness	Hole Size in Sheet +0.13 -0.03	B ±0.08	C Max.	E ±0.13	K ±0.08	P ±0.25	Min. Dist. Hole \varnothing To Edge	
				2	3	4	6	8	10	12	14										16
				(2)	(2)	(2)	(2)	(2)	(2)	(2)	(2)										(2)
M3 x 0.5	KFB3	M3	2	3	4	6	8	10	12	14	16	2.29	1.27-1.65	4.22	3.23	4.2	5.56	4.55	1	4.33	
M4 x 0.7	KFB3	M4	2	3	4	6	8	10	12	14	16	2.29	1.27-1.65	6.4	5.23	6.33	8.74	6.68	1	6.36	
"F" Min. Thread Length (Where Applicable)				Full			9.5 ± 0.4														

(1) Blind at shank end with .375" minimum thread length from head end.

(2) Not applicable. NA - Not Available.



FASTENERS FOR USE WITH PC BOARDS

TYPE KSSB BROACHING SNAP-TOP® STANDOFFS



PART NUMBER DESIGNATION

KSSB - 156 - 12

↓ ↓ ↓
 Type and Top Board Length
 Material Mounting Code
 Hole
 Diameter
 Code

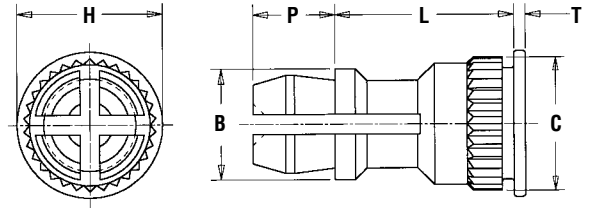

All dimensions are in inches.

UNIFIED	Type	Top Board Mounting Hole Diameter Code	Length "L" ±.005 (Length Code is in 32nds of an inch)										B ±.005	C ±.003	H ±.005	P ±.005	T ±.005
			.250	.312	.375	.437	.500	.562	.625	.750	.875	1.00					
KSSB	156	8	10	12	14	16	18	20	24	28	32	.188	.226	.250	.141	.020	

All dimensions are in millimeters.

METRIC	Type	Top Board Mounting Hole Diameter Code	Length "L" ±0.13 (Length Code is in millimeters)										B ±0.13	C ±0.08	H ±0.13	P ±0.13	T ±0.13
			8	10	12	14	16	18	20	22	25						
KSSB	4MM	8	10	12	14	16	18	20	22	25	4.8	5.74	6.35	3.58	0.51		

TYPE KSSB APPLICATION DATA

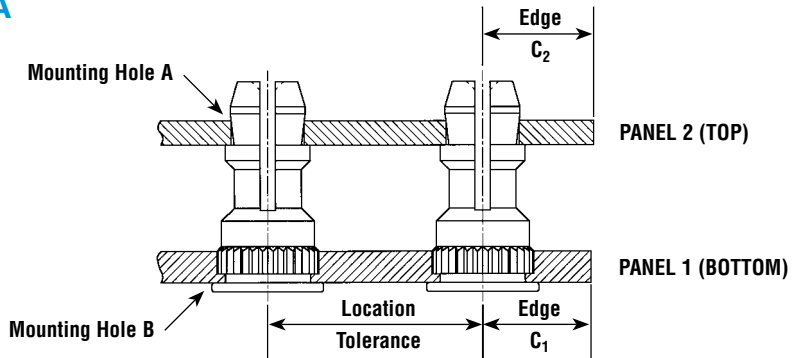

All dimensions are in inches.

UNIFIED	Type	PANEL 1 (Bottom)					PANEL 2 (Top)					
		Bottom Mounting Hole B +.003 - .000	Material	Hardness Max.	Thickness Min.	Edge Distance C ₁ Min.	Location Tolerance Max.	Top Mounting Hole A +.003 - .000	Material	Hardness Max.	Thickness Range	Edge Distance C ₂ Min.
KSSB		.213	PC Board	HRB 65	.050	.220	±.005	.156	PC Board or Metal	No Limit	.040 - .070	.100

All dimensions are in millimeters.

METRIC	Type	PANEL 1 (Bottom)					PANEL 2 (Top)					
		Bottom Mounting Hole B +0.08	Material	Hardness Max.	Thickness Min.	Edge Distance C ₁ Min.	Location Tolerance Max.	Top Mounting Hole A +0.08	Material	Hardness Max.	Thickness Range	Edge Distance C ₂ Min.
KSSB		5.4	PC Board	HRB 65	1.25	5.6	±0.13	4	PC Board or Metal	No Limit	1 - 1.8	2.5



FASTENERS FOR USE WITH PC BOARDS

ReelFast® SURFACE MOUNT CAPTIVE PANEL SCREWS

Patented.

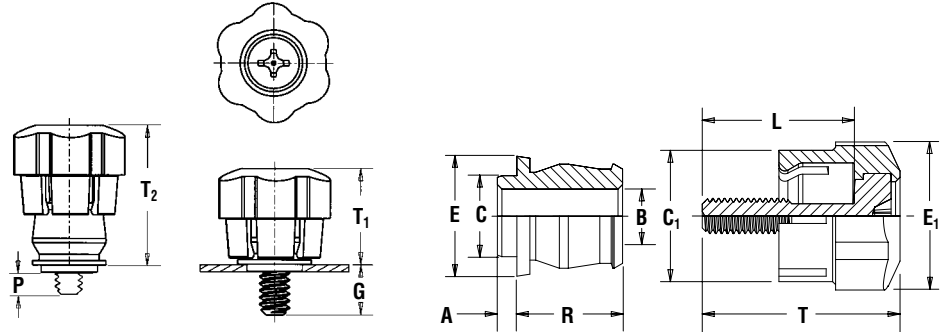
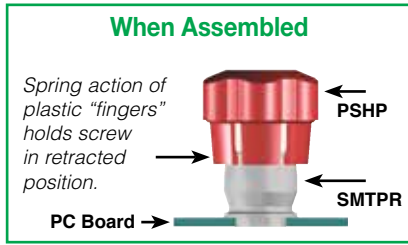

All dimensions are in inches.

UNIFIED	Screw Part Number				Assembly Dimensions					Screw Dimensions				Retainer Dimensions						
	Thread Size	Type	Thread Code	Screw Length Code	Retainer Part Number	G ±.025	P ±.025	T ₁ Nom.	T ₂ Nom.	Total Radial Float	C ₁ ±.010	E ₁ ±.010	L ±.015	T Nom.	A (Shank) Max.	Min. Sheet Thick.	B ±.003	C Max.	E Nom.	R ±.005
	.112-40 (#4-40)	PSHP	440	0 1	SMTPR-6-1	.188 .248	.000 .026	.478	.646	.015	.440	.542	.510 .570	.663 .723	.060	.060	.167	.249	.375	.325
.138-32 (#6-32)	PSHP	632	0 1	SMTPR-6-1	.188 .248	.000 .026	.478	.646	.020	.440	.542	.510 .570	.663 .723	.060	.060	.167	.249	.375	.325	

All dimensions are in millimeters.

METRIC	Screw Part Number				Assembly Dimensions					Screw Dimensions				Retainer Dimensions						
	Thread Size x Pitch	Type	Thread Code	Screw Length Code	Retainer Part Number	G ±0.64	P ±0.64	T ₁ Nom.	T ₂ Nom.	Total Radial Float	C ₁ ±0.25	E ₁ ±0.25	L ±0.38	T Nom.	A (Shank) Max.	Min. Sheet Thick.	B ±0.08	C Max.	E Nom.	R ±0.13
	M3 x 0.5	PSHP	M3	0 1	SMTPR-6-1	4.78 6.3	0 .66	12.14	16.41	.38	11.18	13.77	12.95 14.48	16.84 18.36	1.53	1.53	4.24	6.33	9.53	8.26
M3.5 x 0.6	PSHP	M3.5	0 1	SMTPR-6-1	4.78 6.3	0 .66	12.14	16.41	.51	11.18	13.77	12.95 14.48	16.84 18.36	1.53	1.53	4.24	6.33	9.53	8.26	

RETAINER - Packaged on 13" recyclable reels of 465 pieces. Tape width is 24mm. Supplied with Kapton® patch for vacuum pick up. Reels conform to EIA-481.

SCREW - Packaged in bags. Retainers and screws are sold separately.

PART NUMBER DESIGNATION FOR SCREW

PSHP - 632 - 0 L 001

Type Thread Code Length Code Cap Style Color Code
(Lobed) (Standard Black)

PART NUMBER DESIGNATION FOR RETAINER

SMTPR - 6 - 1 ET

Type Retainer Size Shank Code Finish Code

COLOR CAPABILITIES FOR TYPE PSHP SCREW

The colors shown here (codes #002 thru #007) are non-stocked standards and available on special order. Since actual cap colors may vary slightly from those shown here, we recommend that you request samples for color verification. If you require a custom color or you need a "color matched" cap, please contact us.

Std. Black #001 Red #002 Orange #003 Yellow #004



Non-flammable UL 94-V0 plastic caps are available on special order.

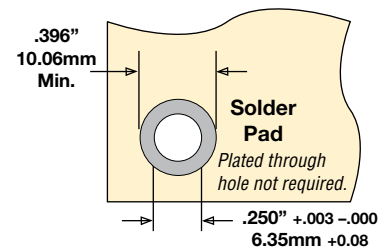
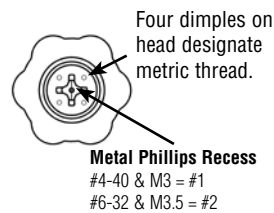

Stencil Masking Examples



FASTENERS FOR USE WITH PC BOARDS

TYPE PFK BROACHING CAPTIVE PANEL SCREWS



PART NUMBER DESIGNATION

PFK - **632** - **62**
 ↓ ↓ ↓
 Type Thread Size Code Screw Length Code

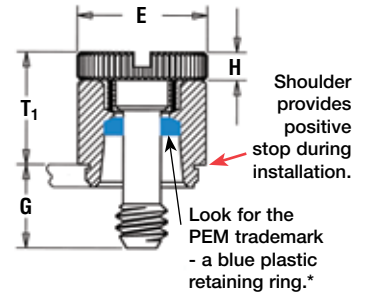
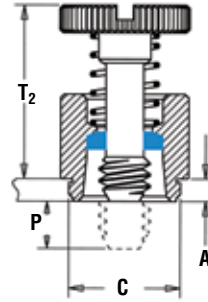
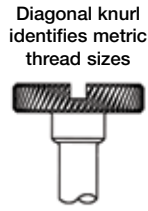

All dimensions are in inches.

UNIFIED	Thread Size	Type	Thread Code	Screw Length Code	A (Shank) Max.	Min. Sheet Thickness	Hole Size In Sheet +.003 - .000	C ±.003	E ±.010	G ±.016	H ±.005	P ±.025 (1)	T ₁ Max.	T ₂ Nom.	Min. Dist. Hole \varnothing To Edge
	.112-40 (#4-40)	PFK	440	40	.060	.060	.265	.283	.312	.250	.072	.000	.36	.54	.20
62				.375						.125					
84				.500						.250					
.138-32 (#6-32)	PFK	632	40	.060	.060	.281	.299	.344	.250	.072	.000	.36	.54	.26	
			62						.375		.125				
			84						.500		.250				

All dimensions are in millimeters.

METRIC	Thread Size x Pitch	Type	Thread Code	Screw Length Code	A (Shank) Max.	Min. Sheet Thickness	Hole Size In Sheet +0.08	C ±0.08	E ±0.25	G ±0.4	H ±0.13	P ±0.64 (1)	T ₁ Max.	T ₂ Nom.	Min. Dist. Hole \varnothing To Edge
	M3 x 0.5	PFK	M3	40	1.53	1.53	6.73	7.19	7.92	6.4	1.83	0	9.14	13.72	5.08
62				9.5						3.2					
84				12.7						6.4					

*Retaining rings are plastic with normal 250°F / 120°C temperature limit.
 (1) Screw may protrude .005"/0.13mm beyond nominal dimensions.



FASTENERS FOR USE WITH PC BOARDS

TYPE KFH BROACHING STUDS



PART NUMBER DESIGNATION

KFH - **632** - **8** **ET**
 ↓ ↓ ↓ ↓
 Type and Thread Length Finish
 Material Code Code Code Code

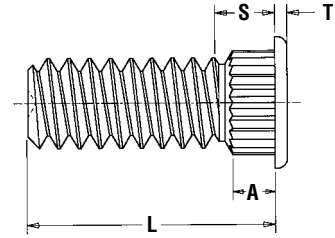
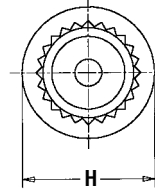

All dimensions are in inches.

UNIFIED	Thread Size	Type	Thread Code	Length "L" ±.010 (Length Code is in 16ths of an inch)					A (Shank) Max.	Min. Sheet Thickness	Hole Size in Sheet +.003 -.000	Max. Hole Size in Attached Parts	H ±.010	S Max. (1)	T ±.005	Min. Dist. Hole \varnothing To Edge	
				.250	.312	.375	.500	.625									.750
	.112-40 (#4-40)	KFH	440	4	5	6	8	10	12	.065	.060	.120	.145	.180	.09	.020	.15
	.138-32 (#6-32)	KFH	632	4	5	6	8	10	12	.065	.060	.140	.170	.200	.09	.020	.19
	.164-32 (#8-32)	KFH	832	4	5	6	8	10	12	.065	.060	.166	.195	.225	.09	.020	.20
	.190-32 (#10-32)	KFH	032	4	5	6	8	10	12	.065	.060	.189	.220	.250	.09	.020	.20

All dimensions are in millimeters.

METRIC	Thread Size x Pitch	Type	Thread Code	Length "L" ±0.25 (Length Code is in millimeters)					A (Shank) Max.	Min. Sheet Thickness	Hole Size in Sheet +0.08	Max. Hole Size in Attached Parts	H ±0.25	S Max. (1)	T ±0.13	Min. Dist. Hole \varnothing To Edge	
				6	8	10	12	15									18
	M3 x 0.5	KFH	M3	6	8	10	12	15	18	1.65	1.53	3	3.7	4.58	2.3	0.51	3.8
	M4 x 0.7	KFH	M4	6	8	10	12	15	18	1.65	1.53	4.2	4.8	5.74	2.3	0.51	5.1
	M5 x 0.8	KFH	M5	6	8	10	12	15	18	1.65	1.53	5	5.8	6.6	2.3	0.51	5.3

(1) Threads are gageable to within 2 pitches of the "S" Max. dimension. A class 3B/5H maximum material commercial nut shall pass up to the "S" Max. dimension.

FASTENERS FOR USE WITH PC BOARDS

ReelFast® SURFACE MOUNT RIGHT ANGLE (R'ANGLE®) FASTENERS



PART NUMBER DESIGNATION

SMTRA - 256 - 8 - 6 - ET

Type Thread Code Height Code Length Code Finish Code



Patented.

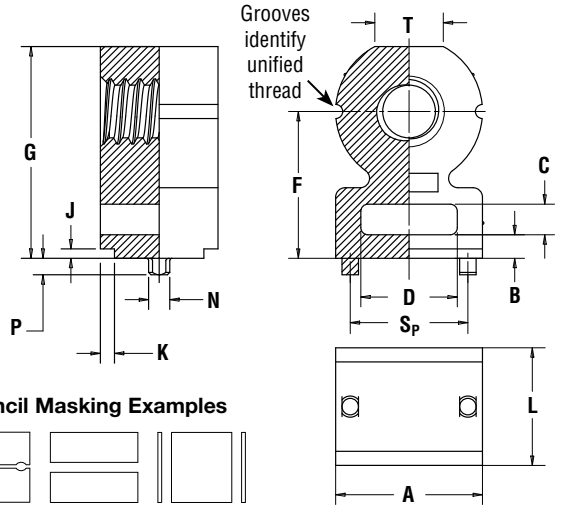
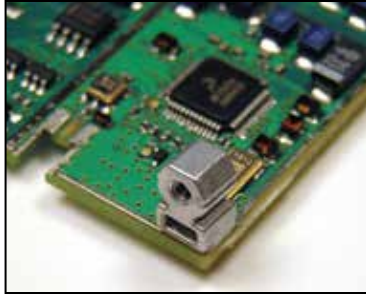

Stencil Masking Examples

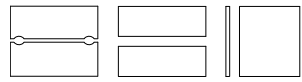

All dimensions are in inches.

UNIFIED	Thread Size	Type	Thread Code	Height Code	Length Code	Length L ±.005	Min. Sheet Thickness	Hole Size In Sheet +.003 -.000	A ±.006	B ±.006	C ±.006	D ±.006	Height F ±.006	G ±.006	J Nom.	K Nom.	N Max.	P Max.	Sp ±.003	T Nom.
	.086-56 (#2-56)	SMTRA	256	8	6	.188	.040	.053	.218	.040	.060	.140	.250	.345	.020	.030	.048	.040	.157	.105
	.112-40 (#4-40)	SMTRA	440	9	6	.188	.040	.053	.250	.050	.065	.160	.281	.390	.020	.030	.048	.040	.188	.125
	.138-32 (#6-32)	SMTRA	632	10	8	.250	.040	.053	.312	.050	.065	.205	.312	.450	.020	.030	.048	.040	.250	.145
	.164-32 (#8-32)	SMTRA	832	12	9	.281	.040	.053	.375	.050	.075	.250	.375	.535	.020	.030	.048	.040	.312	.195

All dimensions are in millimeters.

METRIC	Thread Size x Pitch	Type	Thread Code	Height Code	Length Code	Length L ±0.13	Min. Sheet Thickness	Hole Size In Sheet +0.08	A ±0.15	B ±0.15	C ±0.15	D ±0.15	Height F ±0.15	G ±0.15	J Nom.	K Nom.	N Max.	P Max.	Sp ±0.08	T Nom.
	M2 x 0.4	SMTRA	M2	6	5	5	1	1.35	5.5	1	1.5	3.5	6	8.4	0.5	0.75	1.22	1	4	2.65
	M2.5 x 0.45	SMTRA	M25	6	5	5	1	1.35	5.5	1	1.5	3.5	6	8.4	0.5	0.75	1.22	1	4	2.65
	M3 x 0.5	SMTRA	M3	7	5	5	1	1.35	6.35	1.25	1.65	4	7	9.75	0.5	0.75	1.22	1	4.75	3.2
	M4 x 0.7	SMTRA	M4	9	7	7	1	1.35	9.53	1.25	1.65	6.35	9	13.1	0.5	0.75	1.22	1	7.9	4.8

UNIFIED	Thread Code	Pad Width PA Min.	Pad Length PL Min.	Hole Spacing SH ±.002	Hole Size In Sheet +.003 -.000
	256	.262	.171	.157	.053
	440	.294	.171	.188	.053
	632	.356	.233	.250	.053
	832	.419	.264	.312	.053

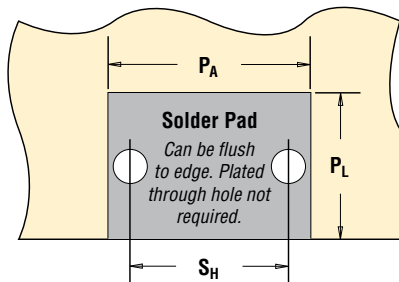

METRIC	Thread Code	Pad Width PA Min.	Pad Length PL Min.	Hole Spacing SH ±0.05	Hole Size In Sheet +0.08
	M2	6.62	4.57	4	1.35
	M25	6.62	4.57	4	1.35
	M3	7.47	4.57	4.75	1.35
	M4	10.65	6.57	7.9	1.35

Part Number	Parts Per Reel	Pitch (mm)	Tape Width (mm)
SMTRA256-8-6	375	16	24
SMTRA440-9-6	300	16	24
SMTRA632-10-8	200	20	32
SMTRA832-12-9	200	20	32
SMTRAM2-6-5	375	16	24
SMTRAM25-6-5	375	16	24
SMTRAM3-7-5	300	16	24
SMTRAM4-9-7	200	20	32



FASTENERS FOR USE WITH PC BOARDS

TYPE SFK SpotFast® CLINCH/BROACH MOUNT FASTENERS

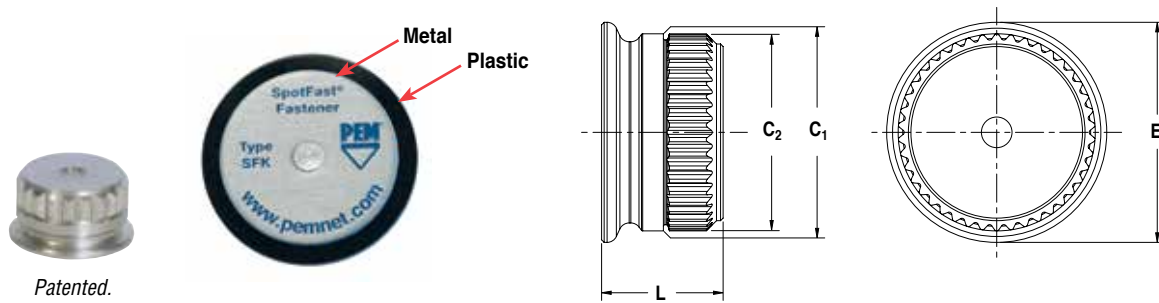

Type and Size	Thickness Code	Panel 1				Panel 2				C ₁ Max.		C ₂ ±0.08mm / ±.003"		E Max.		L Max.		Min. Dist Hole To Edge	
		Thickness ±0.08mm / ±.003"		Mounting Hole +0.08mm / +.003" - .000"		Thickness Min. (1)		Mounting Hole +0.08mm / +.003" - .000"											
		mm	in.	mm	in.	mm	in.	mm	in.	mm	in.	mm	in.	mm	in.	mm	in.	mm	in.
SFK-3	0.8	0.8	.031	3	.118	1.6	.063	2.5	.098	2.98	.117	2.9	.114	3.53	.139	2.31	.091	3	0.12
SFK-3	1.0	1	.039	3	.118	1.6	.063	2.5	.098	2.98	.117	2.9	.114	3.76	.148	2.51	.099	3	0.12
SFK-3	1.2	1.2	.047	3	.118	1.6	.063	2.5	.098	2.98	.117	2.9	.114	3.76	.148	2.72	.107	3	0.12
SFK-3	1.6	1.6	.063	3	.118	1.6	.063	2.5	.098	2.98	.117	2.9	.114	3.76	.148	3.12	.123	3	0.12
SFK-5	0.8	0.8	.031	5	.197	1.6	.063	4.5	.177	4.98	.196	4.9	.193	5.56	.219	2.31	.091	5.1	0.20
SFK-5	1.0	1	.039	5	.197	1.6	.063	4.5	.177	4.98	.196	4.9	.193	5.56	.219	2.51	.099	5.1	0.20
SFK-5	1.2	1.2	.047	5	.197	1.6	.063	4.5	.177	4.98	.196	4.9	.193	5.56	.219	2.72	.107	5.1	0.20
SFK-5	1.6	1.6	.063	5	.197	1.6	.063	4.5	.177	4.98	.196	4.9	.193	5.56	.219	3.12	.123	5.1	0.20

(1) Fastener will provide flush application at minimum sheet thickness.

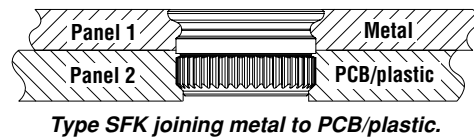
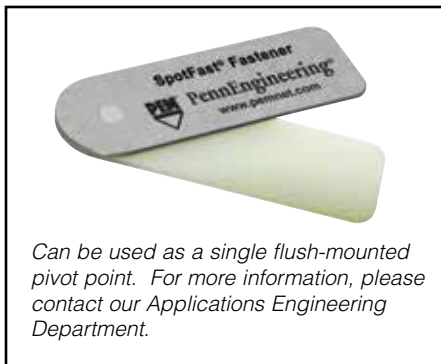

PART NUMBER DESIGNATION

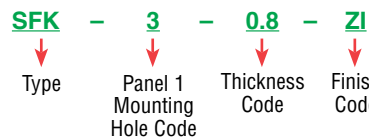

FASTENERS FOR USE WITH PC BOARDS

MATERIAL AND FINISH SPECIFICATIONS

Type	Threads (1)		Fastener Materials					Standard Finishes			Optional Finishes		For Use in Sheet Hardness: (3)				
	Internal, ASME B1.1 2B/ ASME B1.13M 6H	External, ASME B1.1 2A/ ASME B1.13M 6g	Carbon Steel	300 Series Stainless Steel	CDA-510 Phosphor Bronze	CDA-353 Brass	Nylon, Temp. Limit 200° F/ 93° C	Passivated and/or Tested Per ASTM A380	Electro-Plated Bright Tin ASTM B 545, Class B With Clear Preservative Coating	No Finish	Electro-Plated Matte Tin ASTM B 545, Class A With Clear Preservative Coating, Annealed	Black Nitride	HRB 70 / HB 125 or Less	HRB 65 / HB 116 or Less	HRB 60 / HB 107 or Less	HRB 55 / HB 96 or Less	PC Board
KF2	•		•					•			•			•			•
KFS2	•			•				•				•					•
KFE	•		•						•		•			•			•
KFSE	•			•				•				•					•
KFB3	•					•		•		•			•				•
KSSB						•			•				•				•
KFH		•			•			•		•						•	•
PFK Retainer				•				•			•						•
Screw		•		•				•			•						
Spring				•													
Retaining Ring							•										
Part Number Codes For Finishes								None	ET	X	DT	BN					

Type	Threads (1)		Fastener Materials				Standard Finishes (2)			Optional Finish (2)	For Use In Sheet Hardness: (3)	
	Miniature ISO 1501, 4H6	Internal, ASME B1.1 2B/ ASME B1.13M 6H	External, ASME B1.1 2A/ ASME B1.13M 6g	Carbon Steel	ABS Temp. Limit 200° F/ 93° C	Zinc Diecast	Zinc Plated 5µm, Colorless	Electro-Plated Bright Tin ASTM B 545, Class A With Clear Preservative Coating	Bright Nickel Over Copper Flash	Electro-Plated Matte Tin ASTM B 545, Class A With Clear Preservative Coating, Annealed	HRB 80 / HB 150 or less	PC Board
SMTSO	• S1 to S1.4	• 0-80 to 8-32 M1.6 to M4		•				•		•		•
SMTRA		•				•		• (4)		• (4)		•
SMTPR				•				•		•		•
PSHP Cap					•							
Screw			•	•				•				
SFK				•			•				•	•
Part Number Codes For Finishes							ZI	ET	CN	DT		

- (1) For plated studs, Class 2A/6g, the maximum major and pitch diameter, after plating, may equal basic sizes and can be gauged to Class 3A/6h, per ASME B1.1 (see notes at end of table C-1) and ASME B1.13M, Section 8, Paragraph 8.2.
- (2) See PEM Technical Support section of our web site for related plating standards and specifications.
- (3) HRB - Hardness Rockwell "B" Scale. HB - Hardness Brinell.
- (4) Optimal solderability life noted on packaging.

FASTENERS FOR USE WITH PC BOARDS

INSTALLATION

For Types KF2/KFS2/KFE/KFSE/PFK

1. Prepare properly sized mounting hole in board.
2. Place fastener into the anvil hole and place the mounting hole over the shank of the fastener as shown in drawing.
3. With punch and anvil surfaces parallel, apply squeezing force until shoulder contacts the board.

Part Number	D +.003" -.000"	G Min.
PFK-440-40	.173"	.250"
PFK-440-62	.173"	.375"
PFK-440-84	.173"	.500"
PFK-632-40	.190"	.250"
PFK-632-62	.190"	.375"
PFK-632-84	.190"	.500"

Part Number	D +0.08mm	G Min.
PFK-M3-40	4.5mm	6.4mm
PFK-M3-62	4.5mm	9.5mm
PFK-M3-84	4.5mm	12.7mm

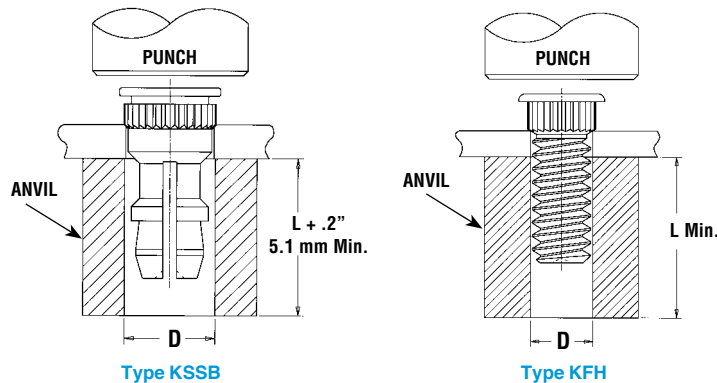
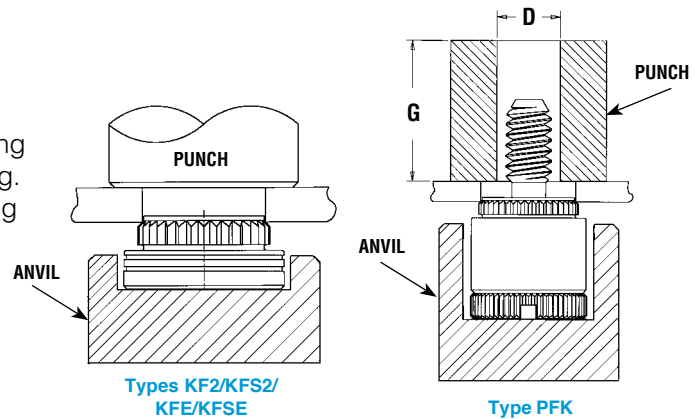

For Types KSSB/KFH

1. Prepare properly sized mounting hole in board.
2. Place fastener into mounting hole as shown in drawing.
3. With punch and anvil surfaces parallel, apply squeezing force until head contacts the board.

Part Number	D +.003" -.000"
KFH-440-L	.113"
KFH-632-L	.140"
KFH-832-L	.166"
KFH-032-L	.191"
KSSB-156-L	.216"

Part Number	D +0.08mm
KFH-M3-L	3.1mm
KFH-M4-L	4.1mm
KFH-M5-L	5.1mm
KSSB-4mm-L	5.49mm

For Type KFB3⁽¹⁾

1. Punch or drill properly sized round mounting hole in board.
2. Place fastener into the anvil hole and place the mounting hole over the shank of the fastener as shown in diagram to the left.
3. Using a punch flaring tool and a recessed anvil, apply squeezing force until the shoulder of the fastener contacts the board. As the fastener seats itself in the proper position, the punch tool will flare the extended portion of the shank outward to complete the installation. The combination of broaching and flaring provides high pushout performance.

(1) PennEngineering manufactures and stocks the installation tooling for the KFB3.

Thread Code	Length Code	Anvil	Punch (Flaring Tool)
#4-40	-2	975201213300	975201231400
#4-40	-4 to -8	975200846300	
#4-40	-10 to -12	975200847300	
#4-40	-16 to -20	975200848300	
#4-40	-20 to -24	975200882300	
#6-32	-2	975201215300	975201232400
#6-32	-4 to -8	975200849300	
#6-32	-10 to -12	975200850300	
#6-32	-16 to -20	975200851300	
#6-32	-22 to -24	975200883300	
#6-32	-28 to -32	975200884300	

Thread Code	Length Code	Anvil	Punch (Flaring Tool)
M3	-2	975201213300	975201231400
M3	-3 to -6	975200846300	
M3	-8 to -10	975200847300	
M3	-12 to -14	975201222300	
M3	-14 to -16	975200848300	
M4	-2	975201216300	975201221400
M4	-3 to -6	975201217300	
M4	-8 to -10	975201218300	
M4	-12 to -14	975201220300	
M4	-14 to -16	975201219300	

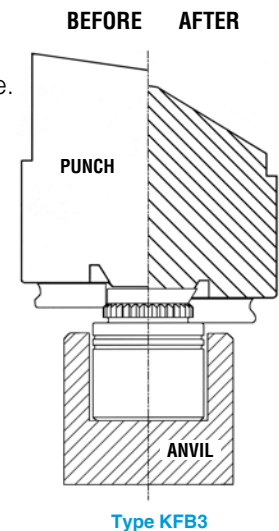

FASTENERS FOR USE WITH PC BOARDS

INSTALLATION

For Type SFK

- Step 1.** Prepare properly sized mounting hole in both panels.
- Step 2.** Using only Panel 1, with the punch and anvil surfaces parallel, apply squeezing force until the fastener is flush with the top of Panel 1.
- Step 3.** Place Panel 2 over fastener and apply squeezing force.

ANVIL DIMENSIONS

Size	C ±0.13/±.003 (mm) / (in.)	Punch Part No.	Anvil Part No.*
SFK-3	3.05 / .120	975200048	970200229300
SFK-5	5.05 / .199	975200048	970200020300

* Part number for anvil used in Step 2

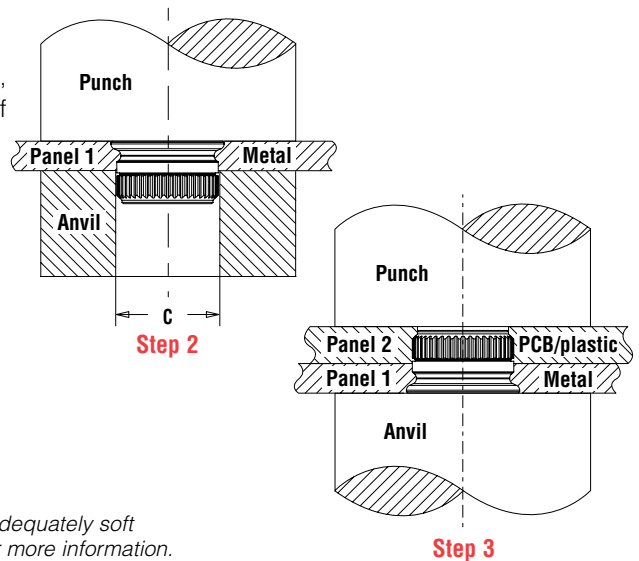

NOTE: Fastener can be installed in both sheets at once when metal panel is adequately soft compared to the non-metal panel. E-mail techsupport@pemnet.com for more information.

For SMT Nuts and Standoffs

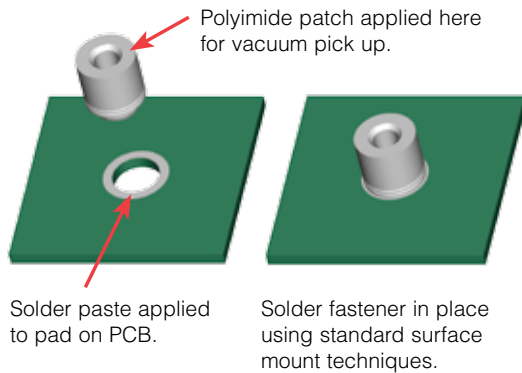

For SMT R'ANGLE® Fasteners

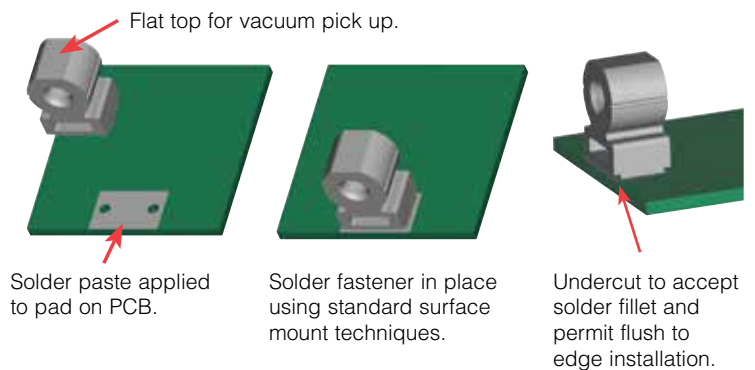

For SMT Captive Panel Screws

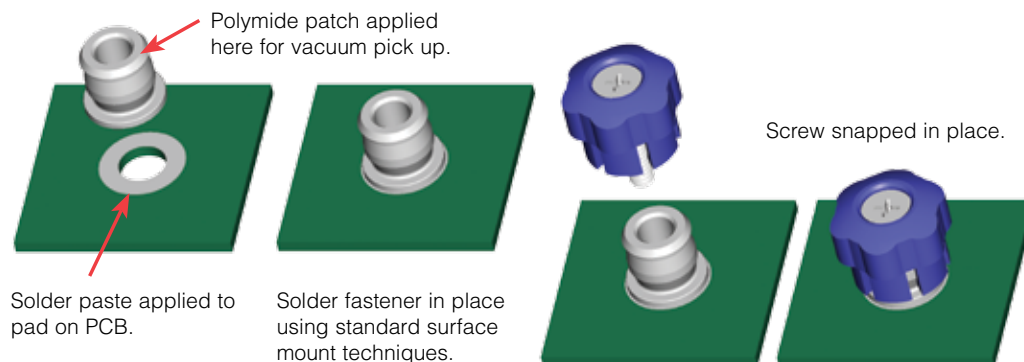

FASTENERS FOR USE WITH PC BOARDS

PERFORMANCE DATA⁽¹⁾

TYPES KF2/KFS2/KFE/KFSE/KFB3/KFH/PFK BROACHING AND BROACH/FLARE MOUNT FASTENERS

UNIFIED	Type	Thread Code	Max. Nut Tightening Torque (in. lbs.)	Test Sheet Thickness & Test Sheet Material	Installation (lbs.)	Pushout (lbs.) (2)	Torque-out (in. lbs.)
	KF2	256	(3)	.060" FR-4 Panel	400	60	6
		440	(3)	.060" FR-4 Panel	400	65	15
	KFS2	632	(3)	.060" FR-4 Panel	500	80	30
		832	(3)	.060" FR-4 Panel	700	95	35
	KFSE	032	(3)	.060" FR-4 Panel	700	100	40
		KFB3	440	(3)	.060" FR-4 Panel	1,000	140
	632		(3)	.060" FR-4 Panel	1,500	170	28
	KFH	440	4	.060" FR-4 Panel	400	65	7
		632	8	.060" FR-4 Panel	400	70	11
832		15	.060" FR-4 Panel	400	80	16	
032		18	.060" FR-4 Panel	400	90	17	
PFK	440	(3)	.060" FR-4 Panel	250	55	(3)	
	632	(3)	.060" FR-4 Panel	400	60	(3)	

METRIC	Type	Thread Code	Max. Nut Tightening Torque (N•m)	Test Sheet Thickness & Test Sheet Material	Installation (kN)	Pushout (N) (2)	Torque-out (N•m)
	KF2 KFS2 KFE KFSE	M3	(3)	1.5 mm FR-4 Panel	2.2	290	1.7
		M4	(3)	1.5 mm FR-4 Panel	2.2	420	3.4
		M5	(3)	1.5 mm FR-4 Panel	2.9	440	4.5
	KFB3	M3	(3)	1.5 mm FR-4 Panel	4.4	560	2.03
		M4	(3)	1.5 mm FR-4 Panel	6	680	3.2
	KFH	M3	0.45	1.5 mm FR-4 Panel	1.8	285	0.79
		M4	1.6	1.5 mm FR-4 Panel	1.8	355	1.8
		M5	2.1	1.5 mm FR-4 Panel	1.8	400	1.92
	PFK	M3	(3)	1.5 mm FR-4 Panel	1.1	245	(3)

TYPE KSSB BROACHING SNAP-TOP® STANDOFFS

UNIFIED	Type	Panel 1 (.060" FR-4 Panel) (4)		Panel 2 (Removable) (4)		
		Installation (lbs.)	Pushout (lbs.)	Max. First On Force (lbs.)	Min. First Off Force (lbs.)	Min. 15th Off Force (lbs.)
	KSSB	500	110	13	3.0	1.0

METRIC	Type	Panel 1 (1.5 mm FR-4 Panel) (4)		Panel 2 (Removable) (4)		
		Installation (kN)	Pushout (N)	Max. First On Force (N)	Min. First Off Force (N)	Min. 15th Off Force (N)
	KSSB	2.2	484	57.7	13.3	4.4

(1) The values reported are averages when all installation specifications and procedures are followed. Variations in mounting hole size, sheet material, and installation procedure will affect results. Performance testing of this product in your application is recommended. We will be happy to provide samples for this purpose or perform the installation for you.

(2) These are typical values for parts installed in drilled mounting holes. Punched mounting holes yield values approximately 15% less.

(3) Not applicable.

(4) See Application Data drawing on page 7.

PEMSERTER® PRESSES

For best results we recommend using a PEMSERTER® press for installation of PEM broaching fasteners. For more information on our line of presses check our web site.

FASTENERS FOR USE WITH PC BOARDS

PERFORMANCE DATA⁽¹⁾

TYPE SFK SpotFast® CLINCH/BROACH MOUNT FASTENERS

Type and Size	Thickness Code	Installation into Panel 1		Installation into Panel 2		Pushout of Panel 2 ⁽²⁾	
		Cold-rolled Steel		FR-4 Fiberglass			
		kN	lbs.	kN	lbs.	N	lbs.
SFK-3	0.8	6.2	1400	1.8	400	200	45
SFK-3	1.0	8	1800	1.8	400	200	45
SFK-3	1.2	8.9	2000	1.8	400	200	45
SFK-3	1.6	10.2	2300	1.8	400	200	45
SFK-5	0.8	11.1	2500	1.8	400	400	90
SFK-5	1.0	13.5	3000	1.8	400	400	90
SFK-5	1.2	15.6	3500	1.8	400	400	90
SFK-5	1.6	17.8	4000	1.8	400	400	90

(1) The values reported are averages when all installation specifications and procedures are followed. Variations in mounting hole size, sheet material, and installation procedure will affect results. Performance testing of this product in your application is recommended. We will be happy to provide samples for this purpose or perform the installation for you.

(2) In most applications, pullout strength of the SFK fastener in Panel 1 exceeds pushout strength of Panel 2.

TYPE SMTSO NUTS AND SPACERS/STANDOFFS⁽³⁾⁽⁴⁾

Pushout						Torque-out					
SMTSO-440 SMTSO-M3		SMTSO-632 SMTSO-M3.5		SMTSO-832 SMTSO-M4		SMTSO-440 SMTSO-M3		SMTSO-632 SMTSO-M3.5		SMTSO-832 SMTSO-M4	
lbs.	N	lbs.	N	lbs.	N	in-lbs.	N-m	in-lbs.	N-m	in-lbs.	N-m
56.5	251	93.5	416	151.1	672	8.56	1.0	13.83	1.6	26.96	3.0

TYPE SMTSO microPEM™ FASTENERS⁽³⁾⁽⁴⁾

Pushout			Torque-out		
SMTSO-080, SMTSO-M1, SMTSO-M1.2 SMTSO-M1.4, SMTSO-M1.6			SMTSO-080, SMTSO-M1, SMTSO-M1.2 SMTSO-M1.4, SMTSO-M1.6		
lbs.	N		in-oz	N-cm	
85.1	378.7		79	56	

TYPE SMTPR RETAINERS⁽³⁾

Pushout	
SMTPR-6-1ET	
lbs.	N
161.4	718

TYPE SMTRA R'ANGLE® FASTENERS WITH ET FINISH⁽³⁾⁽⁴⁾

SMTRA256-8-6		SMTRA440-9-6		SMTRA632-10-8		SMTRA832-12-9		SMTRAM2-6-5		SMTRAM25-6-5		SMTRAM3-7-5		SMTRAM4-9-7	
Pushout (lbs.)	Side Load (lbs.)	Pushout (lbs.)	Side Load (lbs.)	Pushout (lbs.)	Side Load (lbs.)	Pushout (lbs.)	Side Load (lbs.)	Pushout (N)	Side Load (N)	Pushout (N)	Side Load (N)	Pushout (N)	Side Load (N)	Pushout (N)	Side Load (N)
51.7	7.1	89.5	10.8	110.3	8.4	137.2	21.2	418.2	56.8	216.5	36.9	257.6	41.3	369.3	73.3

TESTING CONDITIONS

Oven	Quad ZCR convection oven with 4 zones	Vias	None
High Temp	518°F / 270°C	Spokes	2 Spoke Pattern
Board Finish	62% Sn, 38% Pb	Paste	Amtech NC559LF Sn96.5/3.0Ag/0.5Cu (SAC305) - Lead-free
Board	.062" thick, Single Layer FR-4	Stencil	.0067" / 0.17 mm thick
Screen Printer	Ragin Manual Printer		

(3) With lead-free paste. Average values of 30 test points. The data presented here is for general comparison purposes only. Actual performance is dependent upon application variables. We will be happy to provide samples for you to install. If required, we can also test your installed hardware and provide you with the performance data specific to your application.

(4) Further testing details can be found in our website's literature section.



FASTENERS FOR USE WITH PC BOARDS

OTHER FASTENERS FOR CONSIDERATION TO USE WITH PC BOARDS

TYPE PF11MW™ FLOATING CAPTIVE PANEL SCREWS

(See PEM® Bulletin PF)

Unique flare mount feature allow fasteners to “float” in mounting hole.

- Compensates for mating thread misalignment.
- Installs into any panel material.
- Appropriate for close center-line-to-edge applications.
- Color coded knobs available.

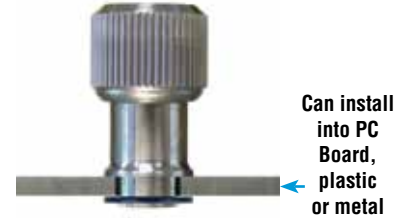

TYPE PF11MF™ FLARE-MOUNTED CAPTIVE PANEL SCREWS

(See PEM® Bulletin PF)

- Appropriate for close centerline-to-edge applications.
- Doesn't require high installation force.
- Installs into any panel material.
- Installs flush on back side of panel.
- Color coded knobs available.



TYPE SOAG/SOSG GROUNDING STANDOFFS

(See PEM® Bulletin SO)

- Designed for clinching into steel or aluminum chassis.
- “Gripping teeth” on opposite side of standoff firmly contact mating PC Board.

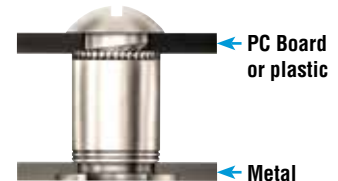

TYPE SKC KEYHOLE® STANDOFFS

(See PEM® Bulletin SK)

- Clinch feature mounts fastener permanently into metal sheet.
- Allows for quick attachment and detachment of PC Board.
- Head is flush or sub-flush in metal sheet.
- Makes horizontal or vertical component mounting possible.

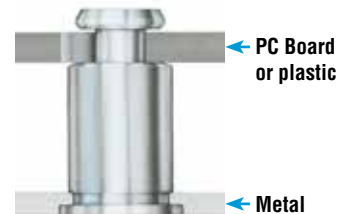

TYPE SSA/SSC/SSS SNAP-TOP® STANDOFFS

(See PEM® Bulletin SSA)

- Spring action holds PC Boards and subassemblies securely, while allowing for quick removal.
- Screws and other threaded hardware are eliminated.

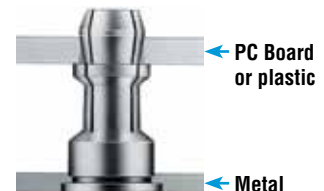

FASTENERS FOR USE WITH PC BOARDS

PEM® TRADEMARKS

For more information on these and other PEM products, visit our PEMNET™ Resource Center at www.pemnet.com

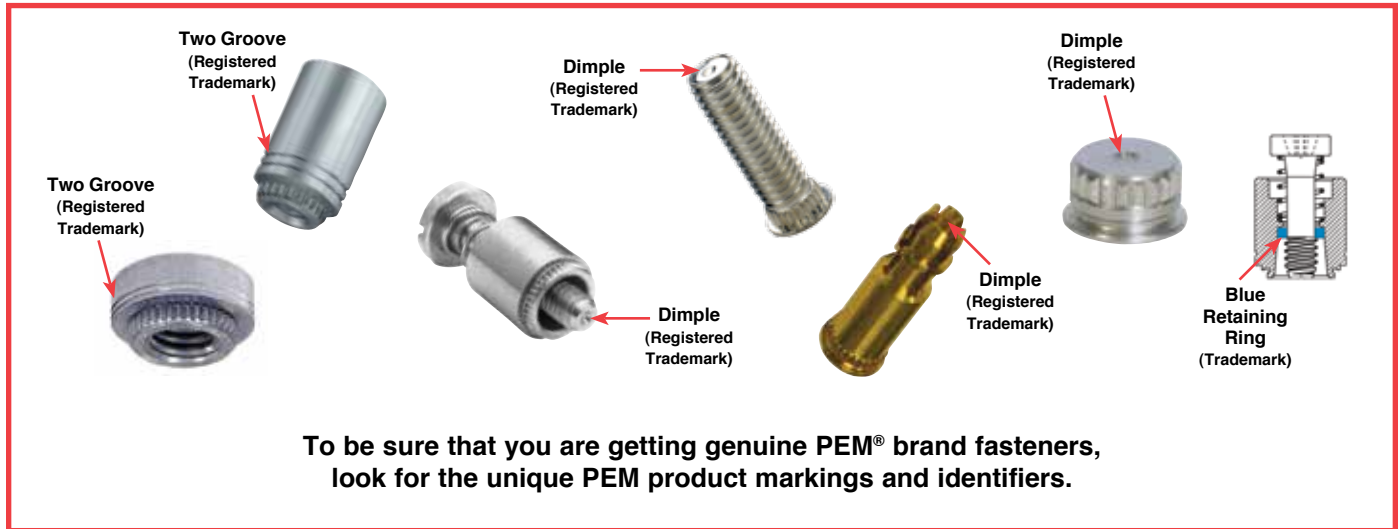

FASTENERS FOR USE WITH PC BOARDS

RoHS compliance information can be found on our website.
© 2012 PennEngineering.

Specifications subject to change without notice.
See our website for the most current version of this bulletin.

PennEngineering®



North America: Danboro, PA USA • E-mail: info@pemnet.com • Tel: +1-215-766-8853 • Fax: +1-215-766-0143 • 800-237-4736 (USA Only)
Europe: Galway, Ireland • E-mail: europe@pemnet.com • Tel: +353-91-751714 • Fax: +353-91-753541
Asia/Pacific: Singapore • E-mail: singapore@pemnet.com • Tel: +65-6-745-0660 • Fax: +65-6-745-2400
Shanghai, China • E-mail: china@pemnet.com • Tel: +86-21-5868-3688 • Fax: +86-21-5868-3988

Visit our PEMNET™ Resource Center at www.pemnet.com

Technical support e-mail: techsupport@pemnet.com