

PennEngineering®

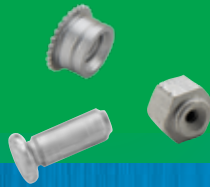

Ideal for today's compact electronics

micro **PEM**® FASTENERS



BULLETIN

MPF



213
REV 513

IDEAL FOR TODAY'S COMPACT ELECTRONICS

- Laptops
- Notebooks/Ultrabook™ Devices
- Tablets/eReaders
- Cell/Smart Phones
- Gaming/Hand Held Devices

Ultrabook™ is a trademark of Intel Corporation



- Threads as small as M1.
- Pin diameters as small as 1mm.
- Standoff lengths as short as .040" / 1mm.
- Clinches into sheets as thin as .016" / 0.4mm.
- Attach sheets as thin as .008" / 0.2mm.

Parts for smaller and/or thinner applications have been designed. Please contact us for more information.



TYPE MPP™ SELF-CLINCHING microPEM® PINS

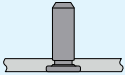

Ideal for micro positioning and alignment applications - **PAGE 3**

TYPE MSO4™ SELF-CLINCHING microPEM® STANDOFFS



Designed for mounting and/or spacing in extremely limited space applications - **PAGE 3**

TYPE TA™ TACKPIN™ FASTENERS



Enable sheet-to-sheet attachment, replacing costly screw installation in applications where disassembly is not required - **PAGES 4 & 5**

microPEM® INSERTS



Strong, durable metal threads in plastics - **PAGE 5**

TYPE SMTSO™ SURFACE MOUNT FASTENERS



These fasteners for compact electronic assemblies attach to P.C. Boards for nut/standoff applications. These fasteners mount on P.C. Boards in the same manner and at the same time as other surface mount components prior to the automated reflow solder process - **PAGE 6**

microPEM® SCREWS



Available in sizes as small as M0.8 and lengths as short as 1mm/.039" - **PAGE 7**

MATERIAL AND FINISH SPECIFICATIONS - **PAGE 8**

INSTALLATION - **PAGES 8-9**

PERFORMANCE DATA - **PAGE 10**



PEM® TYPE MPP™ SELF-CLINCHING microPEM® PINS

- Satisfy demanding micro positioning and alignment applications.
- Head mounts flush into panels as thin as 0.5mm / .02”.
- Chamfered end makes mating hole alignment easy.
- Can be installed into stainless steel sheets.
- Excellent corrosion resistance.
- Can be installed automatically.



PART NUMBER DESIGNATION

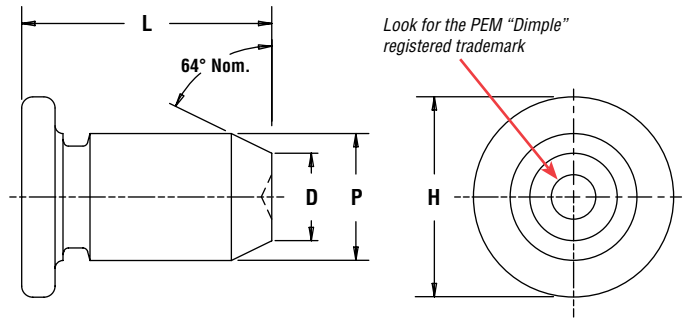
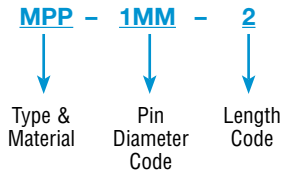

Pin Diameter P ±0.038mm	Type Stainless Steel	Pin Diameter Code	Length Code "L" ± 0.15mm (Length Code in millimeters)							Min. Sheet Thickness		Hole Size In Sheet +0.025mm / +.001"		D ±0.1mm / ±.004"		H ±0.25mm / ±.01"		Min. Distance Hole ⌀ to Edge	
			2	3	4	5	-	-	-	mm	in.	mm	in.	mm	in.	mm	in.	mm	in.
1	MPP	1MM	2	3	4	5	-	-	-	0.5	.02	1.05	.041	0.7	.028	1.6	.063	2.05	.081
1.5	MPP	1.5MM	-	3	4	5	6	8	-	0.5	.02	1.55	.061	1.03	.041	2.24	.088	2.6	.102
2	MPP	2MM	-	-	4	5	6	8	10	0.5	.02	2.05	.081	1.36	.054	3.02	.119	4.4	.173

PEM® TYPE MSO4™ SELF-CLINCHING microPEM® STANDOFFS

- Designed for mounting and/or spacing in extremely limited space applications.
- Can be installed into stainless steel sheets.
- Have stronger threads than weld standoffs because they are made from heat-treated 400 Series Stainless Steel.
- Can be installed automatically.



PART NUMBER DESIGNATION

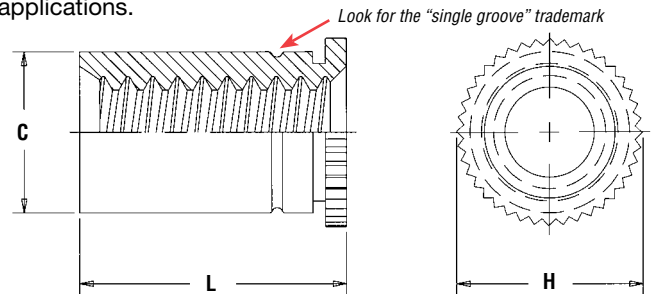
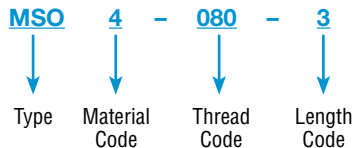

All dimensions are in inches.

UNIFIED	Thread Size	Type	Thread Code	Length Code	Min. Sheet Thickness	Hole Size In Sheet +0.002 - .000	C Max.	H Nom.	L +0.002 - .003	Min. Dist. Hole ⌀ To Edge									
		Stainless Steel																	
	.060-80 (#0-80) (1)	MSO4	080	3	.016	.095	.094	.125	.094	.090									
				4															
				.086-56 (#2-56) (1)							MSO4	256	3	.016	.125	.124	.156	.094	.120
													4						

All dimensions are in millimeters.

METRIC	Thread Size	Type	Thread Code	Length Code	Min. Sheet Thickness	Hole Size In Sheet +0.05	C Max.	H Nom.	L +0.05 - 0.08	Min. Dist. Hole ⌀ To Edge
		Stainless Steel								
	S1 (2)	MSO4	M1	2	0.4	2.41	2.39	3.18	2	2.3
				3						
	S1.2 (2)	MSO4	M1.2	2	0.4	2.41	2.39	3.18	2	2.3
				3						
	S1.4 (2)	MSO4	M1.4	2	0.4	2.41	2.39	3.18	2	2.3
				3						
M1.6 x 0.35 (3)	MSO4	M1.6	2	0.4	2.41	2.39	3.18	2	2.3	
			3							
M2 x 0.4 (3)	MSO4	M2	2	0.4	3.18	3.16	3.96	2	3	
			3							

(1) Unified ASME B1.1, 2B (2) Miniature ISO 1501, 4H6 (3) Metric ASME B1.13M, 6H



CUSTOM microPEM® TackPin™ FASTENER SOLUTIONS

Countersunk TackPin™ Fastener



- Installs into a countersunk hole, replacing countersunk screws.
- Offers flush or near flush appearance.

TackScrew™ Fastener (currently in development)



Patent pending.

- Simple, press-in installation.
- Twist out (unscrew) if removal is required. Can be reinstalled by threading back into hole.
- Approximately 30 lbs. pullout and 5 in-oz.
- Available with Torx Plus®, Mortorq® Super or other drives as required.

MagTack™/PlasTack™ Fasteners (currently in development)



- Simple, press-in installation.
- Secure panels to common magnesium die casting materials such as AZ91D.
- Also, appropriate for attaching panels to plastics such as ABS.

PennEngineering is a licensee for Acument Global Technologies (Torx®, Torx Plus®), and Phillips Screw Company (Mortorq®).

microPEM® INSERTS - STRONG METAL THREADS IN PLASTICS

- Smallest thread size: M1.
- Fastener material: brass and stainless steel.
- Styles: ultrasonic, molded-in and press-in.



PEM® TYPE SMTSO™ SURFACE MOUNT microPEM® FASTENERS

- Hex shaped barrel provides optimal size/performance.
- Provided on tape and reel.
- Reduces board handling.
- Can be installed automatically.

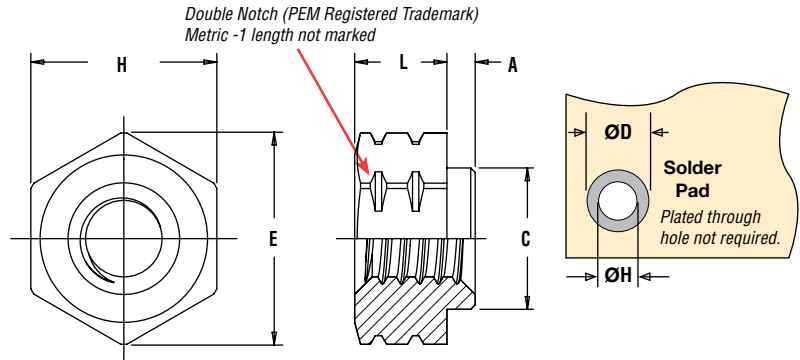
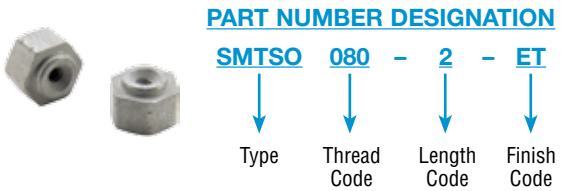

All dimensions are in inches.

UNIFIED	Thread Size	Type	Thread Code	Length Code	Min. Sheet Thickness	A Max.	C Max.	E Ref.	H Nom.	L ±.003	ØH Hole Size In Sheet +.003 -.000	ØD Min. Solder Pad
	.060-80 (#0-80) (1)	SMTSO	080	2	.020	.019	.095	.144	.125	.062	.125	.098

All dimensions are in millimeters.

METRIC	Thread Size	Type	Thread Code	Length Code	Min. Sheet Thickness	A Max.	C Max.	E Ref.	H Nom.	L ±0.08	ØH Hole Size In Sheet +0.08	ØD Min. Solder Pad
	S1 (2)	SMTSO	M1	1	0.5	0.48	2.41	3.66	3.18	1	2.5	4.19
2				2								
3				3								
S1.2 (2)	SMTSO	M1.2	1	0.5	0.48	2.41	3.66	3.18	1	2.5	4.19	
			2						2			
			3						3			
S1.4 (2)	SMTSO	M1.4	1	0.5	0.48	2.41	3.66	3.18	1	2.5	4.19	
			2						2			
			3						3			
M1.6 x 0.35 (3)	SMTSO	M1.6	1	0.5	0.48	2.41	3.66	3.18	1	2.5	4.19	
			2						2			
			3						3			

(1) Unified ASME B1.1, 2B (2) Miniature ISO 1501, 4H6 (3) Metric ASME B1.13M, 6H



Used in reflow solder assembly process for small electronic packages.

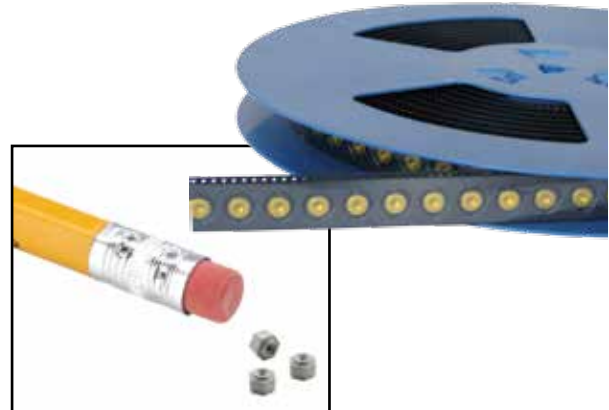

microPEM® SCREWS

- Smallest thread size: M0.8.
- Shortest length: 1mm / .039”.
- Fastener material: steel, stainless steel and aluminum.
- Driver types: Torx®/Torx Plus®/Mortorq® Super Drive System/cross-recess/internal hex
- Head styles: flat head/pan head/socket-head/washer-head/Mortorq® Super-thin Wafer Head.
- Special features: Locking patch, REMFORM®, TAPTITE 2000® and FASTITE 2000®.
- Platings: zinc, nickel, black nickel and black oxide.



MORTORQ® SUPER SPIRAL DRIVE SYSTEM

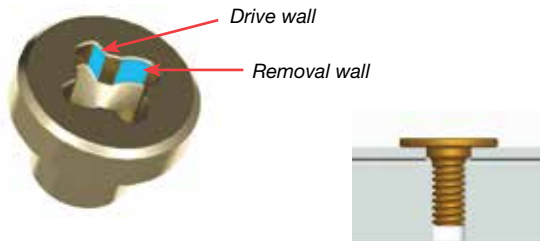

- Exceptionally shallow, super high-strength recess
- Extremely high torque capability without risk of damage to the fastener or surrounding head area
- Full driver contact of recess
- Removal torque capability is increased due to larger removal wall surface area in contact with the driver bit
- Minimal head height reduces the weight of fastened components
- Elegant appearance

REMFORM® SCREWS

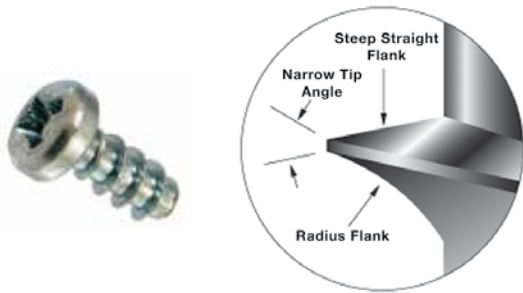

- Designed primarily for plastic applications
- Provides superior performance in a wide range of plastics
- Asymmetrical thread minimizes radial hoop stress to reduce boss bursting
- Narrow tip angle reduces stress in plastic nut member
- Suitable for other ductile materials such as wood and soft metals

TORX PLUS® DRIVE SYSTEM



- 0° drive angle
- Elliptical geometric configuration maximizes drive bit engagement
- Large cross-sectional area at lobes
- Vertical sidewalls
- Optimizes torque transfer
- Virtually eliminates camout
- Reduces end load and worker fatigue
- Reduces annual drive bit costs

PennEngineering is a licensee for Acument Global Technologies (Torx®, Torx Plus®), Phillips Screw Company (Mortorq®) and for Reminc (REMFORM®, TAPTITE 2000®, FASTITE 2000®)

MATERIAL AND FINISH SPECIFICATIONS

Type	Fastener Materials				Standard Finishes			Optional Finishes	For Use in Sheet Hardness: (1)			
	Carbon Steel	Age Hardened A286 Stainless Steel	400 Series Stainless Steel	Aluminum	Passivated and/or Tested Per ASTM A380	Electro-Plated Bright Tin ASTM B 545, Class A With Clear Preservative Coating	Plain Finish	Electro-Plated Matte Tin ASTM B 545, Class A With Clear Preservative Coating, Annealed	HRB 45 / HB 84 or Less	HRB 88 / HB 183 or Less	HRB 92 / HB 202 or Less	PC Board
MPP		•			•						•	
MSO4			•		•					•		
SMTSO	•					•		•				•
TA				•			•		•			
Part Number Codes For Finishes					None	ET	None	DT				

(1) HRB - Hardness Rockwell "B" Scale. HB - Hardness Brinell.

INSTALLATION

TYPE MPP

1. Prepare properly sized mounting hole in sheet. Do not perform any secondary operations such as deburring.
2. Insert pin through mounting hole (punch side) of sheet and into anvil hole.
3. With installation punch and anvil surfaces parallel, apply squeezing force to embed the head of the pin flush in the sheet.

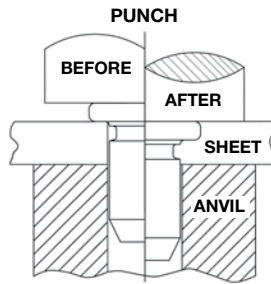

Recommended Installation Anvil

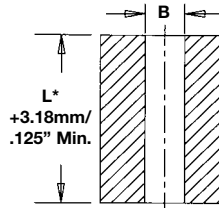

*See page 3 for "L".

Requirements for Installation into Stainless Steel

1. Sheet hardness must be less than the specified limit for the fastener.
2. Panel material should be in the annealed condition.
3. Fastener should be installed in punch side of hole.
4. Mounting hole punch should be kept sharp to minimize work hardening around hole.
5. Maintain the mounting hole punch diameter to no greater than .025mm/.001" over the minimum recommended mounting hole.
6. Fastener should not be installed adjacent to bends or other highly cold-worked areas.

Type	Pin Diameter Code	Anvil Dimensions (mm)		Anvil Part Number	Punch Part Number
		B ±0.02			
MPP	1MM	1.07		8014168	8014167
MPP	1.5MM	1.57		8014169	8014167
MPP	2MM	2.07		8014170	8014167

TYPE MSO4

1. Prepare properly sized mounting hole in sheet. Do not perform any secondary operations such as deburring.
2. Insert standoff through mounting hole (punch side) and into anvil as shown in drawing.
3. With installation punch and anvil surfaces parallel, apply only enough squeezing force to embed the head of the standoff flush in the sheet.

UNIFIED	Type	Thread Code	Anvil Dimensions (inches)		Anvil Part Number	Punch Part Number
			A	B		
	MSO4	080	.112 - .114	.097 - .099	8015796	975200997
MSO4	256	.142 - .144	.127 - .129	8015797	975200997	

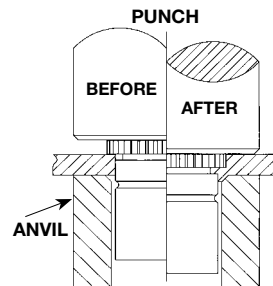

METRIC	Type	Thread Code	Anvil Dimensions (mm)		Anvil Part Number	Punch Part Number
			A	B		
	MSO4	M1	2.84 - 2.89	2.46 - 2.51	8015796	975200997
MSO4	M1.2	2.84 - 2.89	2.46 - 2.51	8015796	975200997	
MSO4	M1.4	2.84 - 2.89	2.46 - 2.51	8015796	975200997	
MSO4	M1.6	2.84 - 2.89	2.46 - 2.51	8015796	975200997	
MSO4	M2	3.6 - 3.65	3.22 - 3.27	8015797	975200997	

Recommended Installation Anvil

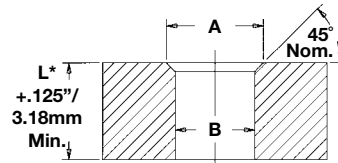

*See page 3 for "L".

INSTALLATION

TYPE SMTSO

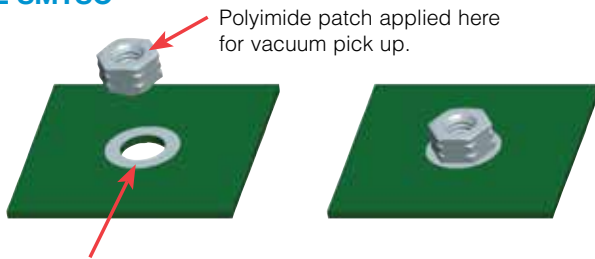

Solder paste applied to pad on PCB.

Solder fastener in place using standard surface mount techniques.

Number of parts per reel/pitch (mm) for each size

Thread Code	Length Code			
	1	2	3	4
080	—	3500 / 8	—	2000 / 8
M1, M1.2, M1.4, M1.6	3500 / 8	2500 / 8	2000 / 8	—

Packaged on 13" recyclable reels. Tape width is 16mm. Supplied with polyimide patch for vacuum pick up. Reels conform to EIA-481.

TYPE TA

1. Prepare properly sized mounting hole in sheet and base panel. Base panel mounting hole can be through or blind.
2. Place sheet and base panel in proper position.
3. Place fastener through hole in sheet and into mounting hole of base panel.
4. With installation punch and anvil surfaces parallel, apply squeezing force until the head of the fastener contacts the top sheet.

Size	Manual Punch Part Number	Manual Anvil Part Number
TA-10-025	8014167	975200046
TA-10-050		
TA-10-075		

microPEM® TackPin™ fasteners can be installed automatically in high volume applications. Contact your nearest Engineering representative for more information.

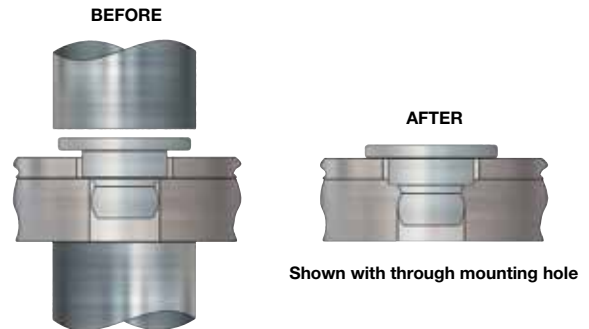
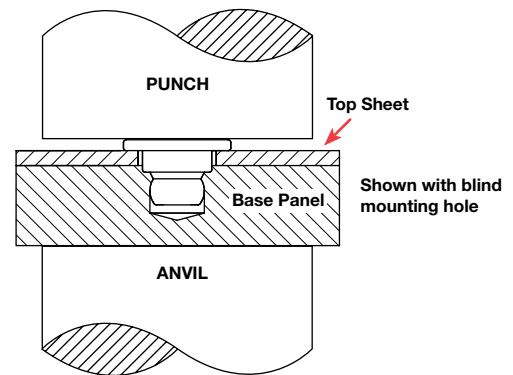

PERFORMANCE DATA⁽¹⁾

TYPE MPP

Type	Pin Diameter Code	Test Sheet Thickness	Installation (kN)	Pushout (N)
MPP	1MM	0.5mm stainless steel HRB 88	10	320
MPP	1.5MM	0.5mm stainless steel HRB 88	12	760
MPP	2MM	0.5mm stainless steel HRB 88	18	860

TYPE MSO4

UNIFIED	Type	Thread Code	Max. Rec. Tightening Torque For Mating Screw (in. lbs.)	Test Sheet Material			
				.017" 300 Series Stainless Steel			
				Installation (lbs.)	Pushout (lbs.)	Torque-out (in. lbs.) (2)	Pull-thru (lbs.) (2)
MSO4	080		.65	2500	64	3	170
MSO4	256		1.9	2500	67	7	265

METRIC	Type	Thread Code	Max. Rec. Tightening Torque For Mating Screw (N•m)	Test Sheet Material			
				0.43 mm 300 Series Stainless Steel			
				Installation (kN)	Pushout (N)	Torque-out (N•m) (2)	Pull-thru (N) (2)
MSO4	M1		.019	11.1	285	0.34	755
MSO4	M1.2		.036	11.1	285	0.34	755
MSO4	M1.4		.057	11.1	285	0.34	755
MSO4	M1.6		.084	11.1	285	0.34	755
MSO4	M2		.28	11.1	300	0.79	1175

TYPE TA

Type	5052-H34 Aluminum			
	Installation		Pushout	
	N	lbs.	N	lbs.
TA-10-025	820	185	80	18
TA-10-050				
TA-10-075				

TYPE SMTSO⁽³⁾⁽⁴⁾

Pushout		Torque-out	
080, M1, M1.2, M1.4, M1.6		080, M1, M1.2, M1.4, M1.6	
lbs.	N	in. lbs.	N•m
85.1	378.7	4.94	0.56

SMTSO TESTING CONDITIONS

Oven Quad ZCR convection oven with 4 zones
High Temp 518°F / 270°C
Board Finish 62% Sn, 38% Pb
Board .062" thick, Single Layer FR-4
Screen Printer Ragin Manual Printer

Vias None
Spokes 2 Spoke Pattern
Paste (lead-free) Amtech NC559LF Sn96.5/3.0Ag/0.5Cu (SAC305)
Stencil .0067" / 0.17mm thick

(1) The values reported are averages when all installation specifications and procedures are followed. Variations in mounting hole size, sheet material and installation procedure will affect results. Performance testing of this product in your application is recommended. We will be happy to provide samples for this purpose.

(2) Performance in torque out and pull thru will depend on the strength and type of screw being used. In most cases the failure will be in the screw and not in the self clinching standoff. Please contact our Applications Engineering group with any questions.

(3) With lead-free paste. Average values of 30 test points. The data presented here is for general comparison purposes only. Actual performance is dependent upon application variables. We will be happy to provide samples for you to install. If required, we can also test your installed hardware and provide you with the performance data specific to your application.

(4) Further testing details can be found in our website's literature section.

To be sure you are getting genuine PEM[®] brand fasteners, look for the unique PEM product markings and identifiers

Single Groove
(Registered trademark)



Dimple
(Registered trademark)



Double Notch
(Registered trademark)



Regulatory compliance information is available in Technical Support section of our website. © 2013 PennEngineering.

Specifications subject to change without notice. See our website for the most current version of this bulletin.

PennEngineering[®]



North America: Danboro, PA USA • E-mail: info@pemnet.com • Tel: +1-215-766-8853 • Fax: +1-215-766-0143 • 800-237-4736 (USA Only)
Europe: Galway, Ireland • E-mail: europe@pemnet.com • Tel: +353-91-751714 • Fax: +353-91-753541
Asia/Pacific: Singapore • E-mail: singapore@pemnet.com • Tel: +65-6-745-0660 • Fax: +65-6-745-2400
Shanghai, China • E-mail: china@pemnet.com • Tel: +86-21-5868-3688 • Fax: +86-21-5868-3988

Visit our **PEMNET™** Resource Center at www.pemnet.com

Technical support e-mail: techsupport@pemnet.com