

PennEngineering®

SELF-CLINCHING STANDOFFS



BULLETIN

SO









SELF-CLINCHING STANDOFFS

PEM® self-clinching standoffs, which use the proven self-clinching design, provide ideal solutions for applications where mounting, spacing or stacking of panels, boards or components are required. Pressed into round holes, these fasteners mount permanently into metal sheets as thin as .025"/0.63mm.

PEM® self-clinching standoffs are also available on special order in non-heat treated carbon steel as Type SON (through hole threaded) or BSON (blind threaded).

For more information on the proper use of PEM self-clinching standoffs, check our web site for Tech Sheet PEM® - REF/Standoff Basics.

<p>Types SO/SOS/SOA through hole threaded self-clinching standoffs for attachment and spacing of panels, boards or components - PAGE 3</p>		<p>Types TSO/TSOS/TSOA Through hole threaded standoffs for clinching into thinner sheets than SO/SOS/SOA types. Install into sheets as thin as .025"/0.63mm. Also, threaded at the barrel end minimizing length of screw required - PAGE 6</p>	
<p>Types BSO/BSOS/BSOA Blind hole, threaded self-clinching standoffs for attachment and spacing of panels, boards or components where flush, closed end is required for smooth panel appearance - PAGE 4</p>		<p>Types DSOS/DSO Through hole, threaded standoffs with round, knurled head allowing closer-to-edge clinch installation for attachment and spacing of panels, boards or components - PAGE 7</p>	
<p>Types SO/SOS/SOA Through hole, unthreaded self-clinching standoffs for stacking and spacing multiple boards or panels - PAGE 5</p>		<p>Types SOSG/SOAG Through hole, threaded grounding standoffs with "gripping teeth" on end of barrel for firm contact of attached PC board - PAGE 7</p>	
<p>Types SO4/BSO4 Threaded blind hole, through hole threaded and unthreaded versions specifically designed for clinching into stainless steel sheets - PAGES 3 (Type SO4) and 4 (Type BSO4)</p>		<p>Material and finish specifications - PAGE 8</p> <p>Installation - PAGES 8 & 9</p> <p>Performance data - PAGES 10 & 11</p>	

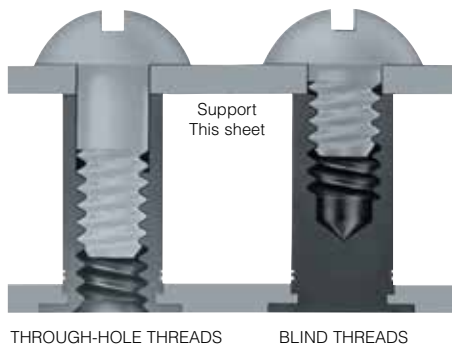

Always look for the "One Groove" or "Two Groove" registered trademarks to be sure you are getting genuine PEM® brand standoffs. On actual parts, location of grooves on barrel may be different than shown in photo.



One groove identifies standoffs for installation into stainless steel.



SELF-CLINCHING STANDOFFS

TYPES SO/SOS/SOA/SO4 THROUGH-HOLE THREADED STANDOFFS

GENERAL DIMENSIONAL DATA

All dimensions are in inches.

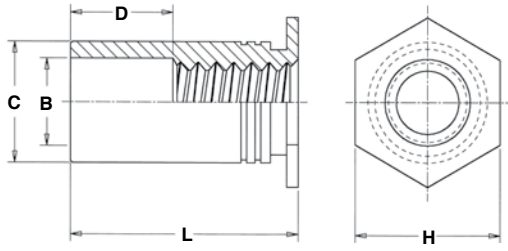

Types SO/SOS/SOA



Type SO4

INSTALLS INTO STAINLESS STEEL

PART NUMBER DESIGNATION

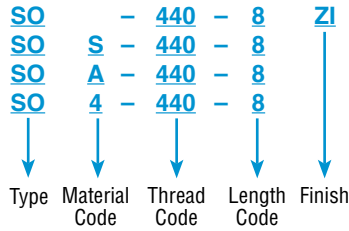

UNIFIED	Thread Code	Min. Sheet Thickness	Hole Size In Sheet +.003 -.000	B Counter-Bore Dia. ±.005	C +.000 -.005	H Nom.	Min. Dist. Hole ϕ To Edge	D ± 0.10
	440	.040	.166	.125	.165	.187	.23	Varies according to length. See length charts below.
	6440	.040	.213	.125	.212	.250	.27	
	632	.040	.213	.156	.212	.250	.27	
	8632	.050	.281	.156	.280	.312	.31	
	832	.050	.281	.188	.280	.312	.31	
032	.050	.281	.203	.280	.312	.31		

All dimensions are in millimeters.

METRIC	Thread Code	Min. Sheet Thickness	Hole Size In Sheet +0.08	B Counter-Bore Dia. ±0.13	C -0.13	H Nom.	Min. Dist. Hole ϕ To Edge	D ± 0.25
	M3	1	4.22	3.2	4.2	4.8	6	Varies according to length. See length charts below.
	3.5M3	1	5.41	3.2	5.39	6.4	6.8	
	M3.5	1	5.41	3.9	5.39	6.4	6.8	
	M4	1.27	7.14	4.8	7.12	7.9	8	
	M5	1.27	7.14	5.35	7.12	7.9	8	

THREAD SIZE AND LENGTH SELECTION DATA

All dimensions are in inches.

UNIFIED	Thread Size	Type				Thread Code	Length "L" +.002 -.005 (Length Code in 32nds of an inch)															
		Fastener Material					.125	.187	.250	.312	.375	.437	.500	.562	.625	.687	.750	.812	.875	.937	1.00	1.062
		Steel	Stainless Steel	Aluminum	Hardened Stainless Steel																	
.112-40 (#4-40)	SO	SOS	SOA	SO4	440	4	6	8	10	12	14	16	18	20	22	24	-	-	-	-	-	
					6440 ⁽¹⁾	4	6	8	10	12	14	16	18	20	22	24	26	28	30	32	34	
.138-32 (#6-32)	SO	SOS	SOA	SO4	632	4	6	8	10	12	14	16	18	20	22	24	26	28	30	32	34	
					8632 ⁽¹⁾	4	6	8	10	12	14	16	18	20	22	24	26	28	30	32	34	
.164-32 (#8-32)	SO	SOS	SOA	SO4	832	4	6	8	10	12	14	16	18	20	22	24	26	28	30	32	34	
.190-32 (#10-32)	SO	SOS	SOA	SO4	032	4	6	8	10	12	14	16	18	20	22	24	26	28	30	32	34	
D Dimension ±0.10						None			.187			.312			.437							

All dimensions are in millimeters.

METRIC	Thread Size x Pitch	Type				Thread Code	Length "L" +0.05 -0.13 (Length Code in millimeters)													
		Fastener Material					3	4	6	8	10	12	14	16	18	20	22	25		
		Steel	Stainless Steel	Aluminum	Hardened Stainless Steel															
M3 x 0.5	SO	SOS	SOA	SO4	M3	3	4	6	8	10	12	14	16	18	-	-	-			
					3.5M3 ⁽¹⁾	3	4	6	8	10	12	14	16	18	20	22	25			
M3.5 x 0.6	SO	SOS	SOA	SO4	M3.5	3	4	6	8	10	12	14	16	18	20	22	25			
M4 x 0.7	SO	SOS	SOA	SO4	M4	3	4	6	8	10	12	14	16	18	20	22	25			
M5 x 0.8	SO	SOS	SOA	SO4	M5	3	4	6	8	10	12	14	16	18	20	22	25			
D Dimension ±0.25						None			4			8			11					

(1) Standoffs with thread codes 6440, 8632, and 3.5M3 offer oversized body for increased bearing surface, wall thickness and performance.

Please contact your local PEM® distributor for availability, minimum quantity, and pricing information.



SELF-CLINCHING STANDOFFS

TYPES BSO/BSOS/BSOA/BSO4 BLIND THREADED STANDOFFS

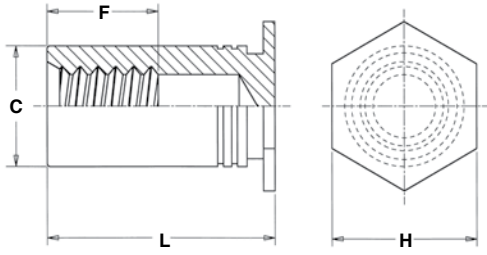

Single groove identifies Type BSO4



PART NUMBER DESIGNATION

BSO	-	440	-	12	ZI
BSO	S	440	-	12	
BSO	A	440	-	12	
BSO	4	440	-	12	
Type	Material Code	Thread Code	Length Code	Finish	

GENERAL DIMENSIONAL DATA

All dimensions are in inches.

UNIFIED	Thread Code	Min. Sheet Thickness	Hole Size In Sheet + .003 -.000	C +.000 -.005	H Nom.	Min. Dist. Hole ϕ To Edge	F Min.
	440	.040	.166	.165	.187	.23	Varies according to length. See length charts below.
	6440	.040	.213	.212	.250	.27	
	632	.040	.213	.212	.250	.27	
	8632	.050	.281	.280	.312	.31	
	832	.050	.281	.280	.312	.31	
032	.050	.281	.280	.312	.31		

All dimensions are in millimeters.

METRIC	Thread Code	Min. Sheet Thickness	Hole Size In Sheet +0.08	C -0.13	H Nom.	Min. Dist. Hole ϕ To Edge	F Min.
	M3	1	4.22	4.2	4.8	6	Varies according to length. See length charts below.
	3.5M3	1	5.41	5.39	6.4	6.8	
	M3.5	1	5.41	5.39	6.4	6.8	
	M4	1.27	7.14	7.12	7.9	8	
	M5	1.27	7.14	7.12	7.9	8	

THREAD SIZE AND LENGTH SELECTION DATA

All dimensions are in inches.

UNIFIED	Thread Size	Type				Thread Code	Length "L" + .002 - .005 (Length Code in 32nds of an inch)											
		Steel	Stainless Steel	Aluminum	Hardened Stainless Steel		.312	.375	.437	.500	.562	.625	.687	.750	.812	.875	.937	1.00
	.112-40 (#4-40)	BSO	BSOS	BSOA	BSO4	440 6440 ⁽¹⁾	10	12	14	16	18	20	22	24	26	28	30	32
.138-32 (#6-32)	BSO	BSOS	BSOA	BSO4	632 8632 ⁽¹⁾	10	12	14	16	18	20	22	24	26	28	30	32	34
.164-32 (#8-32)	BSO	BSOS	BSOA	BSO4	832	10	12	14	16	18	20	22	24	26	28	30	32	34
.190-32 (#10-32)	BSO	BSOS	BSOA	BSO4	032	10	12	14	16	18	20	22	24	26	28	30	32	34
F Dimension Min.							.156	.187	.250			.375						

All dimensions are in millimeters.

METRIC	Thread Size x Pitch	Type				Thread Code	Length "L" + 0.05 - 0.13 (Length Code in millimeters)											
		Steel	Stainless Steel	Aluminum	Hardened Stainless Steel		6	8	10	12	14	16	18	20	22	25		
	M3 x 0.5	BSO	BSOS	BSOA	BSO4	M3 3.5M3 ⁽¹⁾	6	8	10	12	14	16	18	20	22	25		
M3.5 x 0.6	BSO	BSOS	BSOA	BSO4	M3.5	6	8	10	12	14	16	18	20	22	25			
M4 x 0.7	BSO	BSOS	BSOA	BSO4	M4	6	8	10	12	14	16	18	20	22	25			
M5 x 0.8	BSO	BSOS	BSOA	BSO4	M5	6	8	10	12	14	16	18	20	22	25			
F Dimension Min.						3.2	4	5	6.5			9.5						

(1) Standoffs with thread codes 6440, 8632, and 3.5M3 offer oversized body for increased bearing surface, wall thickness and performance.

Please contact your local PEM® distributor for availability, minimum quantity, and pricing information.



SELF-CLINCHING STANDOFFS

TYPES SO/SOS/SOA/SO4 THROUGH-HOLE UNTHREADED STANDOFFS

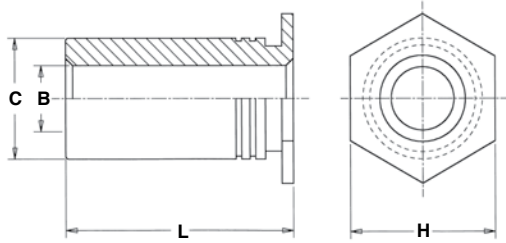

Types SO/SOS/SOA



Type SO4

INSTALLS INTO STAINLESS STEEL

PART NUMBER DESIGNATION

SO - 4116 - 8 ZI
 SO S - 4116 - 8
 SO A - 4116 - 8
 SO 4 - 4116 - 8

↓ ↓ ↓ ↓ ↓
 Type Material Thru-hole Length Finish
 Code Code Code

GENERAL DIMENSIONAL DATA

All dimensions are in inches.

UNIFIED	Thru-hole Code	Min. Sheet Thickness	Hole Size In Sheet +.003 -.000	C +.000 -.005	H Nom.	Min. Dist. Hole \varnothing To Edge
	4116	.040	.166	.165	.187	.23
	6116	.040	.213	.212	.250	.27
	6143	.040	.213	.212	.250	.27
	8143	.050	.281	.280	.312	.31
	8169	.050	.281	.280	.312	.31
8194	.050	.281	.280	.312	.31	

All dimensions are in millimeters.

METRIC	Thru-hole Code	Min. Sheet Thickness	Hole Size In Sheet +0.08	C -0.13	H Nom.	Min. Dist. Hole \varnothing To Edge
	43.1	1	4.22	4.2	4.8	6
	63.1	1	5.41	5.39	6.4	6.8
	63.6	1	5.41	5.39	6.4	6.8
	83.6	1.27	7.14	7.12	7.9	8
	84.1	1.27	7.14	7.12	7.9	8
	85.1	1.27	7.14	7.12	7.9	8

PEM® through-hole, unthreaded standoffs are available on special order only.

THROUGH-HOLE AND LENGTH SELECTION DATA

All dimensions are in inches.

UNIFIED	B Thru-hole Diameter +.004 - .003	Type				Thru-hole Code	Length "L" +.002 - .005 (Length Code in 32nds of an inch)									
		Steel	Stainless Steel	Aluminum	Hardened Stainless Steel		.125	.187	.250	.312	.375	.437	.500	.562	.625	.687
	.116	SO	SOS	SOA	SO4	4116 6116 ⁽¹⁾	4	6	8	10	12	14	16	18	20	22
.143	SO	SOS	SOA	SO4	6143 8143 ⁽¹⁾	4	6	8	10	12	14	16	18	20	22	24
.169	SO	SOS	SOA	SO4	8169	4	6	8	10	12	14	16	18	20	22	24
.194	SO	SOS	SOA	SO4	8194	4	6	8	10	12	14	16	18	20	22	24

All dimensions are in millimeters.

METRIC	B Thru-hole Diameter +0.1 - 0.08	Type				Thru-hole Code	Length "L" +0.05 - 0.13 (Length Code in millimeters)									
		Steel	Stainless Steel	Aluminum	Hardened Stainless Steel		3	4	6	8	10	12	14	16	18	20
	3.1	SO	SOS	SOA	SO4	43.1 63.1 ⁽¹⁾	3	4	6	8	10	12	14	16	18	20
3.6	SO	SOS	SOA	SO4	63.6 83.6 ⁽¹⁾	3	4	6	8	10	12	14	16	18	20	
4.1	SO	SOS	SOA	SO4	84.1	3	4	6	8	10	12	14	16	18	20	
5.1	SO	SOS	SOA	SO4	85.1	3	4	6	8	10	12	14	16	18	20	

(1) Standoffs with through-hole codes 6116, 8143, 63.1 and 83.6 offer oversized body for increased bearing surface, wall thickness and performance.

Please contact your local PEM® distributor for availability, minimum quantity, and pricing information.



SELF-CLINCHING STANDOFFS

TYPES TSO/TSOS/TSOA THREADED STANDOFFS FOR SHEETS AS THIN AS .025"/0.63mm

GENERAL DIMENSIONAL DATA

All dimensions are in inches.

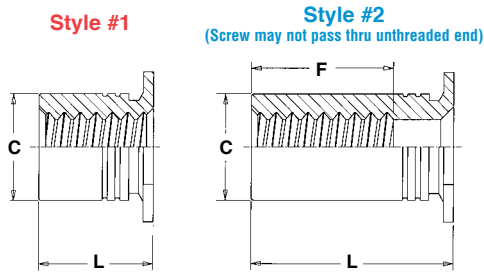

UNIFIED	Thread Code	Min. Sheet Thickness	Hole Size In Sheet +.003 -.000	C +.000 -.005	F Min. Thread Depth	H Nom.	Min. Dist. Hole Φ To Edge
	256	.025	.166	.165	.200	.187	.23
6256	.025	.213	.212	.250		.27	
440	.025	.166	.165	.220	.187	.23	
6440	.025	.213	.212		.250	.27	
632	.025	.213	.212	.270	.250	.27	

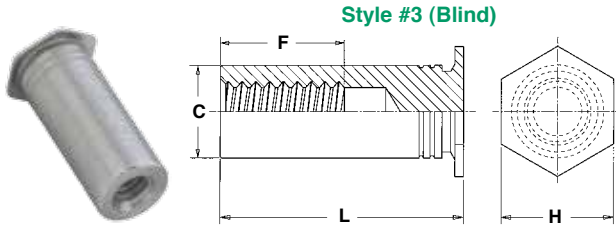

All dimensions are in millimeters.

METRIC	Thread Code	Min. Sheet Thickness	Hole Size In Sheet +0.08	C -0.13	F Min. Thread Depth	H Nom.	Min. Dist. Hole Φ To Edge
	M25	0.63	4.22	4.2	5.2	4.8	5.8
6M25	0.63	5.41	5.39	6.4		7.1	
M3	0.63	4.22	4.2	6.2	4.8	5.8	
6M3	0.63	5.41	5.39		6.4	7.1	
M35	0.63	5.41	5.39	7	6.4	7.1	

THREAD SIZE AND LENGTH SELECTION DATA

All dimensions are in inches.

UNIFIED	Thread Size	Type			Thread Code	Length "L" $\pm .003$ For other lengths / thread depth data see chart below.										
		Steel	Stainless Steel	Aluminum		.090	.125	.187	.250	.312	.375	.437	.500	.562	.625	.687
	Length Code (Length "L" without decimal point)															
.086-56 (#2-56)	TSO	TSOS	TSOA	256	090 ⁽¹⁾	125 ⁽¹⁾	187 ⁽¹⁾	250 ⁽¹⁾	312 ⁽²⁾	375 ⁽²⁾	437 ⁽³⁾	500 ⁽³⁾	562 ⁽³⁾	625 ⁽³⁾	687 ⁽³⁾	750 ⁽³⁾
				6256 ⁽⁴⁾												
.112-40 (#4-40)	TSO	TSOS	TSOA	440	090 ⁽¹⁾	125 ⁽¹⁾	187 ⁽¹⁾	250 ⁽¹⁾	312 ⁽²⁾	375 ⁽²⁾	437 ⁽²⁾	500 ⁽³⁾	562 ⁽³⁾	625 ⁽³⁾	687 ⁽³⁾	750 ⁽³⁾
				6440 ⁽⁴⁾												
.138-32 (#6-32)	TSO	TSOS	TSOA	632	-	125 ⁽¹⁾	187 ⁽¹⁾	250 ⁽¹⁾	312 ⁽¹⁾	375 ⁽²⁾	437 ⁽²⁾	500 ⁽²⁾	562 ⁽³⁾	625 ⁽³⁾	687 ⁽³⁾	750 ⁽³⁾

All dimensions are in millimeters.

METRIC	Thread Size x Pitch	Type			Thread Code	Length "L" ± 0.08 For other lengths / thread depth data see chart below.										
		Steel	Stainless Steel	Aluminum		2.00	3.00	4.00	6.00	8.00	10.00	12.00	14.00	16.00	18.00	19.00
	Length Code (Length "L" without decimal point)															
M2.5 x 0.45	TSO	TSOS	TSOA	M25	200 ⁽¹⁾	300 ⁽¹⁾	400 ⁽¹⁾	600 ⁽¹⁾	800 ⁽²⁾	1000 ⁽³⁾	1200 ⁽³⁾	1400 ⁽³⁾	1600 ⁽³⁾	1800 ⁽³⁾	1900 ⁽³⁾	
				6M25 ⁽⁴⁾												
M3 x 0.5	TSO	TSOS	TSOA	M3	200 ⁽¹⁾	300 ⁽¹⁾	400 ⁽¹⁾	600 ⁽¹⁾	800 ⁽²⁾	1000 ⁽²⁾	1200 ⁽³⁾	1400 ⁽³⁾	1600 ⁽³⁾	1800 ⁽³⁾	1900 ⁽³⁾	
				6M3 ⁽⁴⁾												
M3.5 x 0.6	TSO	TSOS	TSOA	M35	-	300 ⁽¹⁾	400 ⁽¹⁾	600 ⁽¹⁾	800 ⁽¹⁾	1000 ⁽²⁾	1200 ⁽²⁾	1400 ⁽³⁾	1600 ⁽³⁾	1800 ⁽³⁾	1900 ⁽³⁾	

(1) Style #1.

(2) Style #2.

(3) Style #3.

(4) Standoffs with thread codes 6256, 6440, 6M25 and 6M3 offer oversized body for increased bearing surface, wall thickness and performance.

Please contact your local PEM® distributor for availability, minimum quantity, and pricing information.

LENGTH/STYLE DATA

All dimensions are in inches.

(Length can be specified in .001" increments.)

UNIFIED	Thread Code	Length "L" (Style #1)	Length "L" (Style #2)	Length "L" (Style #3)
	256 6256	.090 - .250	.251 - .375	.376 - .750
440 6440	.090 - .280	.281 - .450	.451 - .750	
632	.120 - .350	.351 - .540	.541 - .750	

All dimensions are in millimeters.

(Length can be specified in .02mm increments.)

METRIC	Thread Code	Length "L" (Style #1)	Length "L" (Style #2)	Length "L" (Style #3)
	M25 6M25	2.00 - 6.30	6.32 - 9.50	9.52 - 19.00
M3 6M3	2.00 - 7.50	7.52 - 11.00	11.02 - 19.00	
M35	3.00 - 8.80	8.82 - 12.80	12.82 - 19.00	

PART NUMBER DESIGNATION

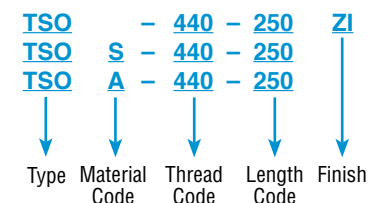

SELF-CLINCHING STANDOFFS

TYPES DSOS/DSO THREADED STANDOFFS FOR CLOSE-TO-EDGE APPLICATIONS



PART NUMBER DESIGNATION

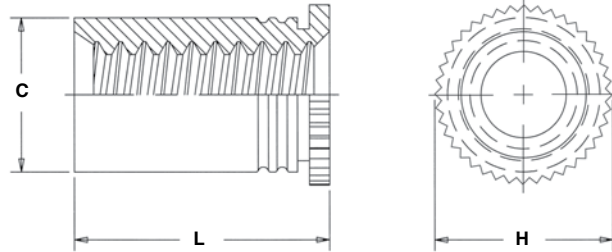
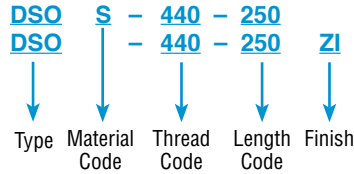

All dimensions are in inches.

UNIFIED	Thread Size (#4-40)	Type		Thread Code	Length Code	Sheet Thickness	Hole Size In Sheet +.003 -.000	C Max.	H Nom.	L ⁽¹⁾ +.002 -.005	Min. Dist. Hole \varnothing To Edge
		Stainless Steel	Steel								
		DSOS	DSO	440	250	.037 - .250	.166	.165	.194	.250	.126
					275					.275	

All dimensions are in millimeters.

METRIC	Thread Size x Pitch	Type		Thread Code	Length Code	Sheet Thickness	Hole Size In Sheet +0.08	C Max.	H Nom.	L ⁽¹⁾ +0.05 -0.13	Min. Dist. Hole \varnothing To Edge
		Stainless Steel	Steel								
	M3 x 0.5	DSOS	DSO	M3	6.35	0.94 - 6.35	4.22	4.2	4.92	6.35	3.2
					7					7	

(1) Available in other lengths on special order.

Please contact your local PEM® distributor for availability, minimum quantity, and pricing information.

TYPES SOSG/SOAG GROUNDING STANDOFFS

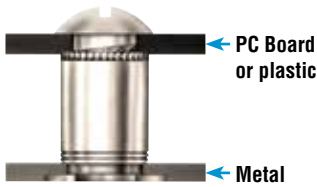

PART NUMBER DESIGNATION

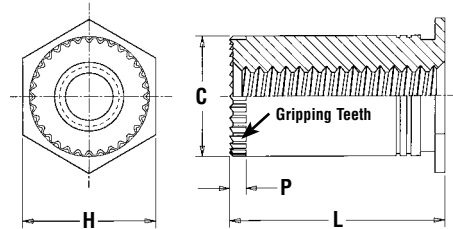
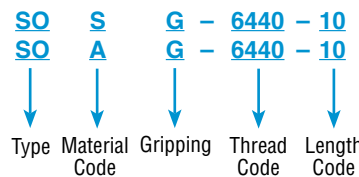

All dimensions are in inches.

UNIFIED	Thread Size (#4-40)	Type		Thread Code	Length "L" +.010 -.000 ⁽²⁾ (Length Code is in 32nds of an inch)						Min. Sheet Thickness	Hole Size In Sheet +.003 -.000	C +.000 -.005	H ±.005	P Nom.	Min. Dist. Hole \varnothing To Edge	
		Stainless Steel	Aluminum		.125	.187	.250	.312	.375	.437							.500
		SOSG	SOAG	6440	4	6	8	10	12	14	16	.040	.213	.212	.250	.030	.27
		SOSG	SOAG	8632	4	6	8	10	12	14	16	.050	.281	.280	.312	.030	.31

All dimensions are in millimeters.

METRIC	Thread Size x Pitch	Type		Thread Code	Length "L" +0.25 ⁽²⁾ (Length Code is in millimeters)						Min. Sheet Thickness	Hole Size In Sheet +0.08	C -0.13	H ±0.25	P Nom.	Min. Dist. Hole \varnothing To Edge
		Stainless Steel	Aluminum		3	4	6	8	10	12						
	M3 x 0.5	SOSG	SOAG	3.5M3	3	4	6	8	10	12	1	5.4	5.39	6.4	0.76	6.8

(2) For special lengths greater than .500" / 12 mm, Types SOSG and SOAG are blind threaded.



SELF-CLINCHING STANDOFFS

MATERIAL AND FINISH SPECIFICATIONS

Type	Threads (1)	Fastener Materials					Standard Finishes			For Use In Sheet Hardness: (3)				
	Internal, ASME B1.1, 2B ASME B1.13M, 6H	Hardened Carbon Steel	Non-heat Treated Carbon Steel	Aluminum	300 Series Stainless Steel	400 Series Stainless Steel	Zinc Plated 5µm, Colorless (2)	Passivated and/or Tested Per ASTM A380	No Finish	HRB 88 / HB 183 or Less	HRB 80 / HB 150 or Less	HRB 70 / HB 125 or Less	HRB 60 / HB 107 or Less	HRB 50 / HB 89 or Less
SO	•	•					•				•			
SOA	•			•					•					•
SOS	•				•			•						
SO4	•					•		•			•			
BSO	•	•					•				•			
BSOA	•			•					•					•
BSOS	•				•			•						
BSO4	•					•		•			•			
TSO	•		•				•						•	
TSOS	•				•			•				•		
TSO4	•			•					•					•
DSO	•	•					•				•			
DSOS	•				•			•				•		
SOAG	•			•					•					•
SOSG	•				•			•			•			
Part Number Codes For Finishes							ZI	None	None					

(1) Where applicable.

(2) See PEM Technical Support section of our web site for related plating standards and specifications.

(3) HRB - Hardness Rockwell "B" Scale. HB - Hardness Brinell.

INSTALLATION

TYPES SO/SOS/SOA/SO4/BSO/BSOS/BSOA/BSO4

1. Prepare properly sized mounting hole in sheet. Do not perform any secondary operation such as deburring.
2. Insert standoff through mounting hole (preferably the punch side) of sheet and into anvil as shown in drawing.
3. With installation punch and anvil surfaces parallel, apply only enough squeezing force to embed the standoff's head flush in the sheet. Drawing at right shows suggested tooling for applying these forces.

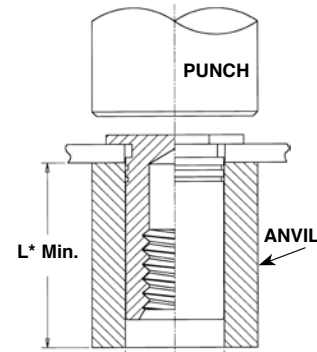

*See pages 3 & 4 for "C" and "L".

+0.004" to +0.007" / +0.1mm to +0.18mm

PEMSERTER® Installation Tooling

Thread Code	Anvil Part Number	Punch Part Number
440/M2/M2.5/M3	970200487300	975200048
632/6440/3.5M3/M3.5	970200012300	
832/8632/M4	970200013300	
032/M5	970200013300	
0420/M6	970200393300	

SELF-CLINCHING STANDOFFS

INSTALLATION

TYPES TSO/TSOS/TSOA

1. Prepare properly sized mounting hole in sheet. Do not perform any secondary operation such as deburring.
2. Insert standoff through mounting hole (preferably the punch side) of sheet and into anvil as shown in drawing.
3. With installation punch and anvil surfaces parallel, apply only enough squeezing force to embed the standoff's head flush in the sheet. Drawing at right shows required installation anvil for sheet thickness of .025" to .032"/0.63 to 0.81mm. A chamfered anvil is not required for sheets over .032"/0.81mm.

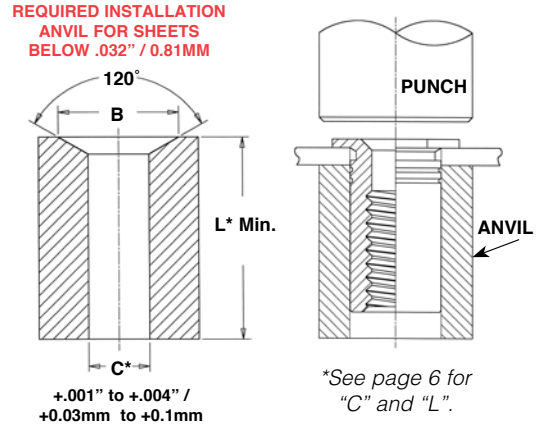

PEMSERTER® Installation Tooling

UNIFIED	Thread Code	Anvil Dimensions (in.) For Sheets Below .032"		Anvil Part No. For Sheets Over .032"	Punch Part Number
		B	Anvil Part No.		
	256/440	.187 - .194	8003291	970200008300	975200048
6256/6440/632	.250 - .257	8003292	970200012300	975200048	

METRIC	Thread Code	Anvil Dimensions (mm) For Sheets Below .63mm		Anvil Part No. For Sheets Over .63mm	Punch Part Number
		B	Anvil Part No.		
	M2.5/M3	4.75 - 4.93	8003291	970200008300	975200048
6M25/6M3/M35	6.35 - 6.53	8003292	970200012300	975200048	

TYPES DSOS/DSO

1. Prepare properly sized mounting hole in sheet. Do not perform any secondary operations such as deburring.
2. Insert fastener through mounting hole (preferably the punch side) and into anvil as shown in drawing.
3. With installation punch and anvil surfaces parallel, apply only enough squeezing force to embed the standoff's head flush in the sheet.

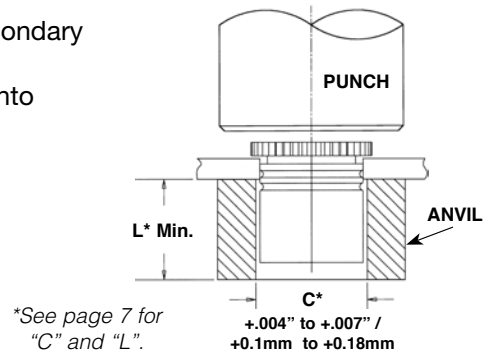

PEMSERTER® Installation Tooling

Thread Code	Anvil Part Number	Punch Part Number
440/M3	970200487300	975200048
6440/3.5M3	970200012300	
8632	970200013300	

TYPES SOSG/SOAG

1. Prepare properly sized mounting hole in sheet. Do not perform any secondary operations such as deburring.
2. Insert fastener through mounting hole (preferably the punch side) and into anvil as shown in drawing.
3. With installation punch and anvil surfaces parallel, apply only enough squeezing force to embed the standoff's head flush in the sheet.

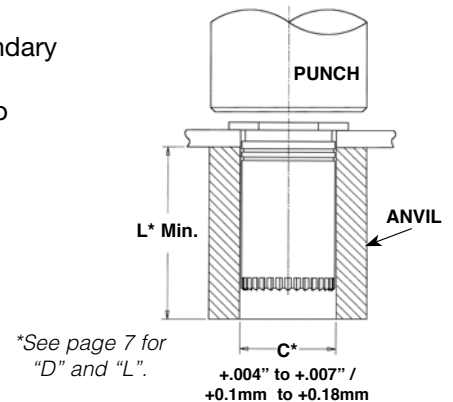

PEMSERTER® Installation Tooling

Thread Code	Anvil Part Number	Punch Part Number
440/M3	970200487300	975200048
6440/3.5M3	970200012300	
8632	970200013300	



SELF-CLINCHING STANDOFFS

PERFORMANCE DATA⁽¹⁾

TYPES SO/SOS/SOA/BSO/BSOS/BSOA

UNIFIED	Thread Code	Standoff Material	Max. Rec. Tightening Torque For Mating Screw (in. lbs.)	Test Sheet Material							
				.060" 5052-H34 Aluminum				.060" Cold-rolled Steel			
				Installation (lbs.)	Pushout (lbs.)	Torque-out (in. lbs.) (2)	Pull-thru (lbs.) (2)	Installation (lbs.)	Pushout (lbs.)	Torque-out (in. lbs.) (2)	Pull-thru (lbs.) (2)
440	Steel	4.75	1100	160	11	280	2200	225	19	330	
	Stainless Steel	3.8	1100	160	11	224	2200	225	19	264	
	Aluminum	2.85	1100	160	11	168	—	—	—	—	
6440	Steel	4.75	1700	300	25	280	3300	420	35	330	
	Stainless Steel	3.8	1700	300	25	224	3300	420	35	264	
	Aluminum	2.85	1700	300	25	168	—	—	—	—	
632	Steel	8.75	1700	300	25	310	3300	420	35	380	
	Stainless Steel	7	1700	300	25	248	3300	420	35	304	
	Aluminum	5.25	1700	300	25	186	—	—	—	—	
8632	Steel	8.75	2400	400	45	310	4000	560	75	380	
	Stainless Steel	7	2400	400	45	248	4000	560	75	304	
	Aluminum	5.25	2400	400	45	186	—	—	—	—	
832	Steel	18	2400	400	45	580	4000	560	75	700	
	Stainless Steel	14.4	2400	400	45	464	4000	560	75	560	
	Aluminum	11	2400	400	45	348	—	—	—	—	
032	Steel	32	2400	400	45	580	4000	560	75	700	
	Stainless Steel	25.6	2400	400	45	464	4000	560	75	560	
	Aluminum	19	2400	400	45	348	—	—	—	—	

METRIC	Thread Code	Standoff Material	Max. Rec. Tightening Torque For Mating Screw (N•m)	Test Sheet Material							
				1.5mm 5052-H34 Aluminum				1.5mm Cold-rolled Steel			
				Installation (kN)	Pushout (N)	Torque-out (N•m) (2)	Pull-thru (N) (2)	Installation (kN)	Pushout (N)	Torque-out (N•m) (2)	Pull-thru (N) (2)
M3	Steel	0.55	4.9	710	1.24	1245	9.8	1000	2.15	1465	
	Stainless Steel	0.44	4.9	710	1.24	996	9.8	1000	2.15	1172	
	Aluminum	0.33	4.9	710	1.24	747	—	—	—	—	
3.5M3	Steel	0.55	7.6	1330	2.82	1245	14.7	1860	3.95	1465	
	Stainless Steel	0.44	7.6	1330	2.82	996	14.7	1860	3.95	1172	
	Aluminum	0.33	7.6	1330	2.82	747	—	—	—	—	
M3.5	Steel	0.91	7.6	1330	2.82	1375	14.7	1860	3.95	1690	
	Stainless Steel	0.73	7.6	1330	2.82	1100	14.7	1860	3.95	1352	
	Aluminum	0.55	7.6	1330	2.82	825	—	—	—	—	
M4	Steel	2	10.7	1780	5.08	2575	17.8	2490	8.47	3110	
	Stainless Steel	1.6	10.7	1780	5.08	2060	17.8	2490	8.47	2488	
	Aluminum	1.2	10.7	1780	5.08	1545	—	—	—	—	
M5	Steel	3.6	10.7	1780	5.08	2575	17.8	2490	8.47	3110	
	Stainless Steel	2.88	10.7	1780	5.08	2060	17.8	2490	8.47	2488	
	Aluminum	2.16	10.7	1780	5.08	1545	—	—	—	—	

(1) The values reported are averages when all installation specifications and procedures are followed. Variations in mounting hole size, sheet material and installation procedure will affect results. Performance testing of this product in your application is recommended. We will be happy to provide samples for this purpose.

(2) Joint failure in torque-out and pull-thru will depend on the strength and type of screw being used. In some cases the failure will be in the screw and not in the self-clinching standoff. Please contact our Applications Engineering group with any questions.

SELF-CLINCHING STANDOFFS

PERFORMANCE DATA⁽¹⁾

TYPES SO4/BSO4

UNIFIED	Thread Code	Max. Rec. Tightening Torque For Mating Screw (in. lbs.)	Test Sheet Material			
			.050" 300 Series Stainless Steel			
			Installation (lbs.)	Pushout (lbs.)	Torque-out (in. lbs.) (2)	Pull-thru (lbs.) (2)
440	4.75	5500	336	17	600	
6440	4.75	9500	647	30	680	
632	8.75	9500	647	30	680	
8632	8.75	10500	900	71	1392	
832	18	10500	900	71	1517	
032	32	10500	900	71	1368	

METRIC	Thread Code	Max. Rec. Tightening Torque For Mating Screw (N•m)	Test Sheet Material			
			1.3mm 300 Series Stainless Steel			
			Installation (kN)	Pushout (N)	Torque-out (N•m) (2)	Pull-thru (N) (2)
M3	0.55	24.5	1493	2.36	2650	
3.5M3	0.55	42.3	2877	3.06	3025	
M3.5	0.91	42.3	2877	3.06	3025	
M4	2	46.7	4003	8.89	6458	
M5	3.6	46.7	4003	8.89	6226	

TYPES TSO/TSOS/TSOA

Standoff "C" Dimension	Standoff Material	Test Sheet Material											
		.025" / 0.64mm 5052-H34 Aluminum				.025" / 0.64mm Cold-rolled Steel							
		Installation		Pushout		Torque-out (2)		Installation		Pushout		Torque-out (2)	
		(lbs.)	(kN)	(lbs.)	(N)	(in. lbs.)	(N•m)	(lbs.)	(kN)	(lbs.)	(N)	(in. lbs.)	(N•m)
.165" / 4.2 mm	Steel	1500	6.7	70	311	6	0.68	2000	8.9	100	445	9	1
	Stainless Steel	1500	6.7	70	311	6	0.68	2000	8.9	100	445	9	1
	Aluminum	1500	6.7	70	311	6	0.68	—	—	—	—	—	—
.212" / 5.39 mm	Steel	1800	8	90	400	11	1.24	2500	11.1	150	667	15	1.7
	Stainless Steel	1800	8	90	400	11	1.24	2500	11.1	150	667	15	1.7
	Aluminum	1800	8	90	400	11	1.24	—	—	—	—	—	—

TYPES DSOS/DSO

UNIFIED	Thread Code	Max. Rec. Tightening Torque For Mating Screw (in. lbs.)	Test Sheet Material					
			.040" 5052-H34 Aluminum			.040" Cold-rolled Steel		
			Installation (lbs.)	Pushout (lbs.)	Torque-out (in. lbs.) (2)	Installation (lbs.)	Pushout (lbs.)	Torque-out (in. lbs.) (2)
440	3.8	1000	50	10	1300	75	10	

METRIC	Thread Code	Max. Rec. Tightening Torque For Mating Screw (N•m)	Test Sheet Material					
			1mm 5052-H34 Aluminum			1mm Cold-rolled Steel		
			Installation (kN)	Pushout (N)	Torque-out (N•m) (2)	Installation (kN)	Pushout (N)	Torque-out (N•m) (2)
M3	0.44	4.5	223	1.1	5.8	334	1.1	

TYPES SOSG/SOAG





UNIFIED	Thread Code	Test Sheet Thickness and Test Sheet Material	Installation (lbs.)	Pushout (lbs.)	Torque-out (in. lbs.) (2)					
						6440	.064" 5052-H34 Aluminum	1700	300	25
						8632	.064" 5052-H34 Aluminum	1700	400	45

METRIC	Thread Code	Test Sheet Thickness and Test Sheet Material	Installation (kN)	Pushout (N)	Torque-out (N•m) (2)					
						3.5M3	1.6mm 5052-H34 Aluminum	7.6	1330	2.82

- (1) The values reported are averages when all installation specifications and procedures are followed. Variations in mounting hole size, sheet material and installation procedure will affect results. Performance testing of this product in your application is recommended. We will be happy to provide samples for this purpose.
- (2) Joint failure in torque-out and pull-thru will depend on the strength and type of screw being used. In some cases the failure will be in the screw and not in the self-clinching standoff. Please contact our Applications Engineering group with any questions.

SELF-CLINCHING STANDOFFS

If you require a standoff which we do not offer in this bulletin, please contact us. We will be happy to work with you to satisfy your special need. For other types of PEM® brand standoffs and spacers see:

	Bulletin CH	PEM® concealed-head standoffs.
	Bulletin K	PEM® broaching and surface mount standoffs for printed circuit boards.
	Bulletin SK	PEM® KEYHOLE® standoffs.
	Bulletin SSA	PEM® brand SNAP-TOP® standoffs.
	Bulletin MPF	PEM® brand microPEM® standoffs.

Regulatory compliance information is available in Technical Support section of our website. © 2013 PennEngineering.

Specifications subject to change without notice. Check our website for the most current version of this bulletin.

PennEngineering®



North America: Danboro, PA USA • E-mail: info@pemnet.com • Tel: +1-215-766-8853 • Fax: +1-215-766-0143 • 800-237-4736 (USA Only)
Europe: Galway, Ireland • E-mail: europe@pemnet.com • Tel: +353-91-751714 • Fax: +353-91-753541
Asia/Pacific: Singapore • E-mail: singapore@pemnet.com • Tel: +65-6-745-0660 • Fax: +65-6-745-2400
Shanghai, China • E-mail: china@pemnet.com • Tel: +86-21-5868-3688 • Fax: +86-21-5868-3988

Visit our PEMNET™ Resource Center at www.pemnet.com

Technical support e-mail: techsupport@pemnet.com